

SERVICE MANUAL

Wireless type Models

MSZ-FA25VA -[E1](WH)

MSZ-FA35VA -[E1](WH)

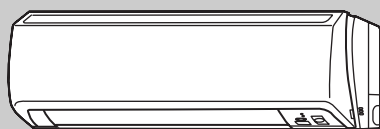

Indication of model name

MSZ-FA25VA -[E1]

MSZ-FA35VA -[E1]



CONTENTS

1. TECHNICAL CHANGES	2
2. PART NAMES AND FUNCTIONS.....	3
3. SPECIFICATION.....	5
4. NOISE CRITERIA CURVES	6
5. OUTLINES AND DIMENSIONS	7
6. WIRING DIAGRAM	8
7. REFRIGERANT SYSTEM DIAGRAM	8
8. SERVICE FUNCTIONS	9
9. TROUBLESHOOTING.....	11
10. DISASSEMBLY INSTRUCTIONS.....	31
11. PARTS LIST.....	35
12. OPTIONAL PARTS.....	38

NOTE:

This service manual describes technical data of the indoor units.

•As for outdoor units MUZ-FA25VA-[E1], MUZ-FA35VA-[E1], MUZ-FA25VAH-[E1] and MUZ-FA35VAH-[E1], refer to service manual OB372.

•As for outdoor units MXZ-3A54VA-[E1], MXZ-4A71VA-[E1] and MXZ-4A80VA-[E1], refer to service manual OB377.



1

TECHNICAL CHANGES

MSZ-A09YV -[E1] → **MSZ-FA25VA** -[E1]

MSZ-A12YV -[E1] → **MSZ-FA35VA** -[E1]

1. Indication of capacity has been changed.(BTU base →kW base)
2. Controller method between indoor and outdoor has been changed.
3. Power supply method has been changed (change to supply from outdoor unit).
4. Power supply cord has been removed.
5. Indoor electronic control P.C. board has been changed.
6. Position of terminal block has been changed.
7. Indoor fan motor has been changed. (AC → DC)
8. Indoor heat exchanger has been changed.
9. The horizontal vane motor unit has been changed.

An external gear is added to the generalized stepping motor.

The unit is structured so that the driving torque and stopping torque would increase.

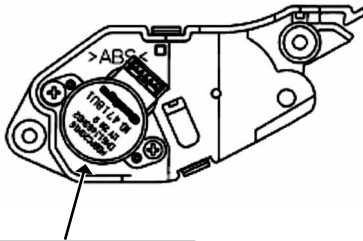

Generalized stepping motor

NOTE: Do not remove the vane motor from the motor unit.
Do not disassemble the horizontal vane motor unit.

10. The vertical vane motor unit has been added.
An external gear is added to the generalized stepping motor.
The unit is structured so that the driving torque and stopping torque would increase.

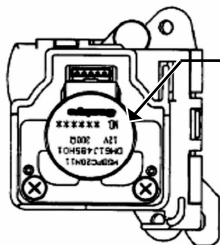

Generalized stepping motor

NOTE: Do not remove the vane motor from the motor unit.
Do not disassemble the vertical vane motor unit.

11. Front panel driving motor unit which opens and closes the front panel has been added.

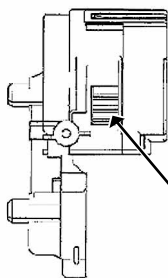

Front panel opening/closing output gear

NOTE: Do not disassemble the front panel driving motor unit.

12. PLASMA DEODORIZING/AIR PURIFYING filter units have been added.
13. i-see Sensor has been added.
(i-see control operation and AREA setting have been added.)
14. Air cleaning filter has been removed.
15. Signal of remote controller has been changed. (It is not available for the conventional models.)
16. Symbol on terminal block has been changed (to S1/S2/S3).

INDOOR UNIT

MSZ-FA25VA -E1

MSZ-FA35VA -E1

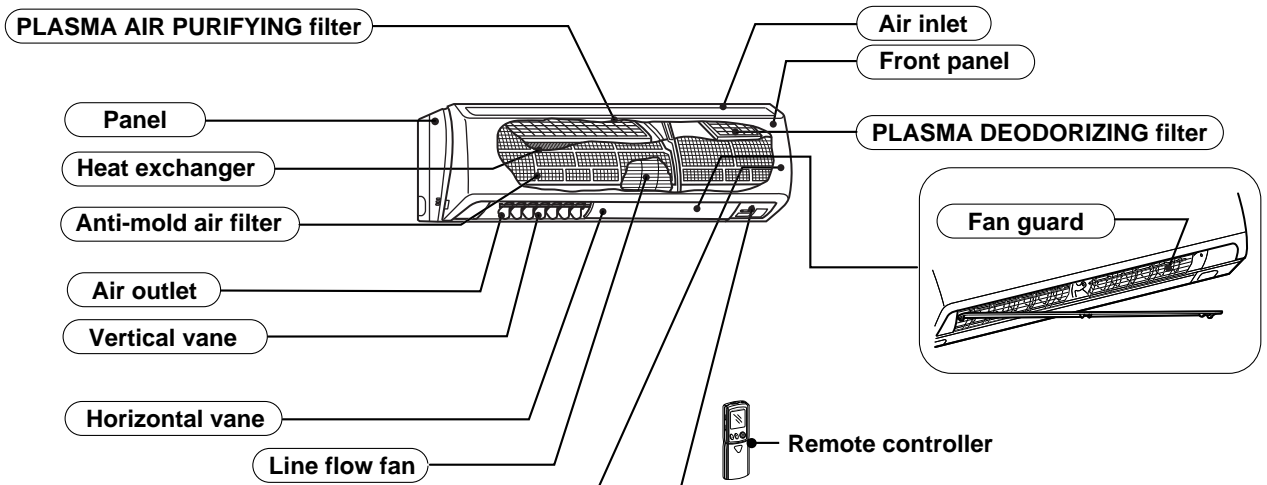

Auto front panel

When the unit starts operating, the front panel opens automatically to draw in air. When the unit stops operating, the front panel closes automatically.

Auto front panel

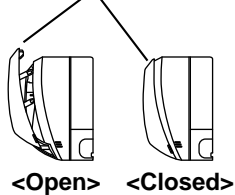

Operation section

(When the front panel is opened)

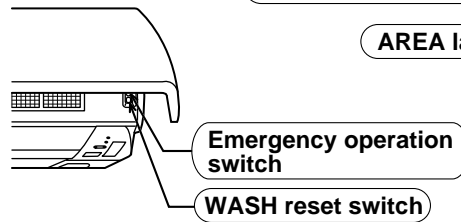

Display section

POWER lamp POWER

PLASMA/WASH lamp PLASMA/WASH

AREA lamp AREA L R

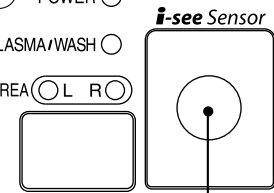

Remote control receiving section

i-see Sensor

AREA lamp indicate AREA setting

In AREA setting, the horizontal air flow direction changes automatically according to the detection of i-see Sensor which detects the floor/ wall temperature to air-condition the room evenly.

i-see control operation

i-see sensor constantly measure floor/wall temperature to automatically adjust to the set temperature by estimating the temperature actually perceived by a person inside the room ("sensible temperature").

MSZ-FA25VA - [E1]

MSZ-FA35VA - [E1]

ACCESSORIES

		MSZ-FA25VA - [E1] MSZ-FA35VA - [E1]
①	Installation plate	1
②	Installation plate fixing screw 4 × 25 mm	5
③	Remote controller holder	1
④	Fixing screw for ③ 3.5 × 1.6 mm (Black)	2
⑤	Battery (AAA) for remote controller	2
⑥	Wireless remote controller	1
⑦	Felt tape (Used for left or left-rear piping)	1

REMOTE CONTROLLER

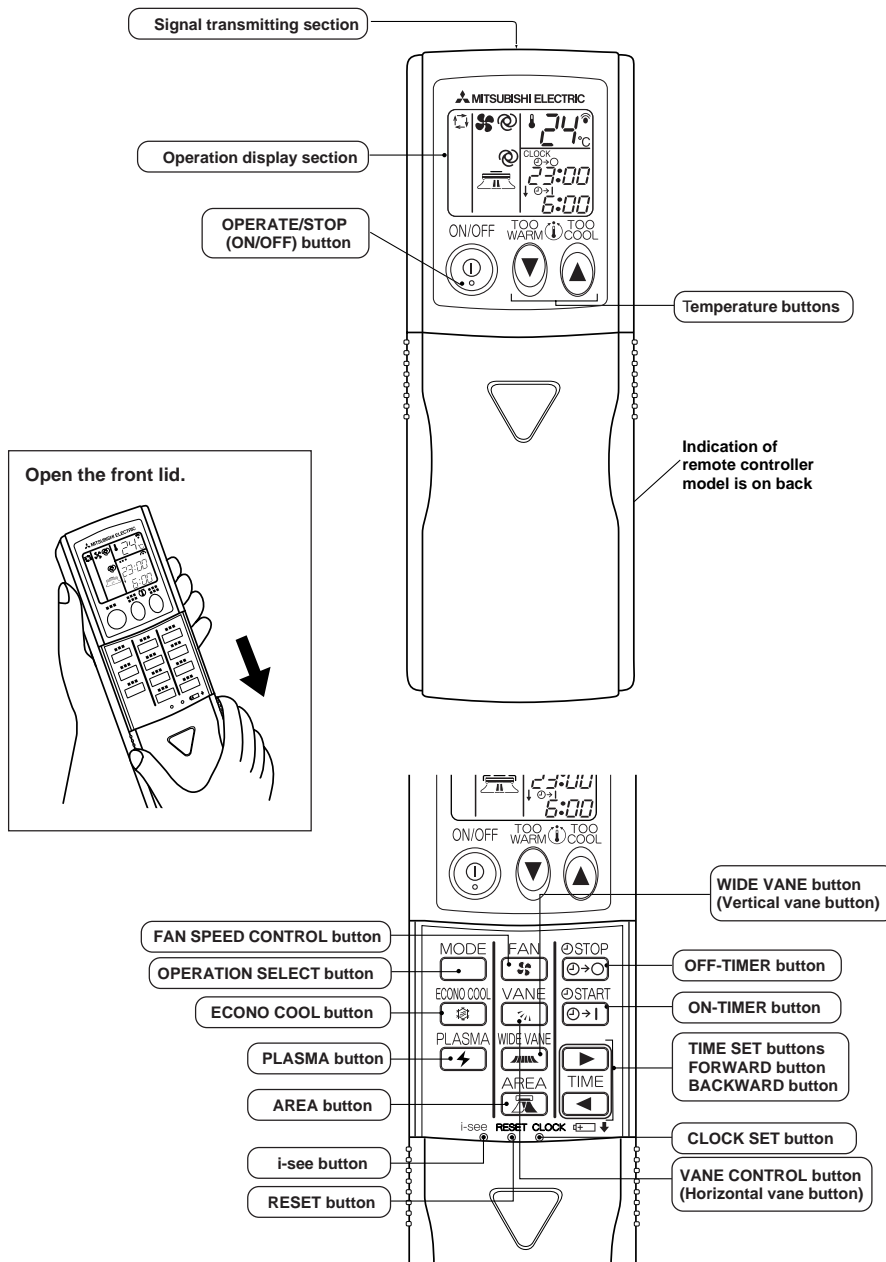

3

SPECIFICATION

Indoor model			MSZ-FA25VA - [E1]		MSZ-FA35VA - [E1]	
Function			Cooling	Heating	Cooling	Heating
Power supply			Single phase 230V,50Hz		Single phase 230V,50Hz	
Capacity	Air flow(Super High)	m³ /h	594	612	594	612
	Air flow(High*/Med.*/Low*)	m³ /h	474*/354*/252*	498*/384*/264*	474*/354*/258*	498*/384*/276*
Electrical data	Power outlet	A	10		10	
	Running current *1	A	0.25		0.25	
	Power input *1	W	33		33	
	Auxiliary heater	A(kW)	—		—	
	Power factor *1	%	57		57	
	Fan motor current *1	A	0.25		0.25	
Fan motor	Model		RC0J40-EB		RC0J40-EB	
	Dimensions W×H×D	mm	780×298×198		780×298×198	
	Weight	kg	10		10	
Special remarks	Air direction		4		4	
	Sound level(Super High)	dB(A)	42		42	
	Sound level(High*/Med.*/Low*)	dB(A)	36*/29*/21*		36*/29*/22*	
	Fan speed(Super High)	rpm	1,220	1,250	1,220	1,250
	Fan speed(High*/Med.*/Low*)	rpm	1,010*/800*/610*	1,050*/850*/640*	1,010*/800*/630*	1,050*/850*/660*
	Fan speed regulator		4		4	
	Thermistor RT11(at25°C)	kΩ	10		10	
	Thermistor RT12(at25°C)	kΩ	10		10	
	Thermistor RT13(at25°C)	kΩ	10		10	
	Remote controller model		KM05A		KM05A	

When outdoor unit is MXZ type.

Indoor model			MSZ-FA25VA - [E1]		MSZ-FA35VA - [E1]	
Function			Cooling	Heating	Cooling	Heating
Capacity	Air flow(Super High)	m³ /h	546	540	642	
	Air flow(High*/Med.*/Low*)	m³ /h	450*/348*/252*	420*/372*/264*	516*/390*/258*	522*/402*/276*
Special remarks	Sound level(Super High)	dB(A)	42		42	
	Sound level(High*/Med.*/Low*)	dB(A)	36*/29*/21*		36*/29*/22*	
	Fan speed(Super High)	rpm	1,130	1,120	1,300	
	Fan speed(High*/Med.*/Low*)	rpm	960*/790*/610*	910*/830*/640*	1,080*/860*/630*	1,090*/880*/660*

NOTE : Test conditions are based on ISO 5151

Cooling : Indoor Dry-bulb temperature 27°C Wet-bulb temperature 19°C

Outdoor Dry-bulb temperature 35°C Wet-bulb temperature 24°C

Heating : Indoor Dry-bulb temperature 20°C Wet-bulb temperature 15°C

Outdoor Dry-bulb temperature 7°C Wet-bulb temperature 6°C

Refrigerant piping length (one way): 5m

* Reference value

*1 Measured under rated operating frequency.

Specifications and rating conditions of main electric parts

INDOOR UNIT

Item	Model	MSZ-FA25VA - [E1]	MSZ-FA35VA - [E1]
Fuse	(F11)	T3.15AL250V	
Front panel driving motor	(MP)	NSEJ001DA1 12V DC 100Ω (at 25°C)	
i-see Sensor motor	(MT)	MP20Z 12V DC 300Ω (at 25°C)	
Horizontal vane motor	(MV1)	MSBPC20M16 12V DC 250Ω (at 25°C)	
Vertical vane motor	(MV2)	MSBPC20M11 12V DC 300Ω (at 25°C)	
Varistor	(NR11)	ERZV14D471	
i-see Sensor	(RR)	A2TPMI334F0V50HSOBA060P5L1J4S 5V DC	
Terminal block	(TB)	3P	

4

NOISE CRITERIA CURVES

MSZ-FA25VA - [E1]

FAN SPEED	FUNCTION	SPL(dB(A))	LINE
Super High	COOLING	42	●—●
	HEATING	42	○—○

Test conditions,

Cooling : Dry-bulb temperature 27°C Wet-bulb temperature 19°C
 Heating : Dry-bulb temperature 20°C Wet-bulb temperature 15°C

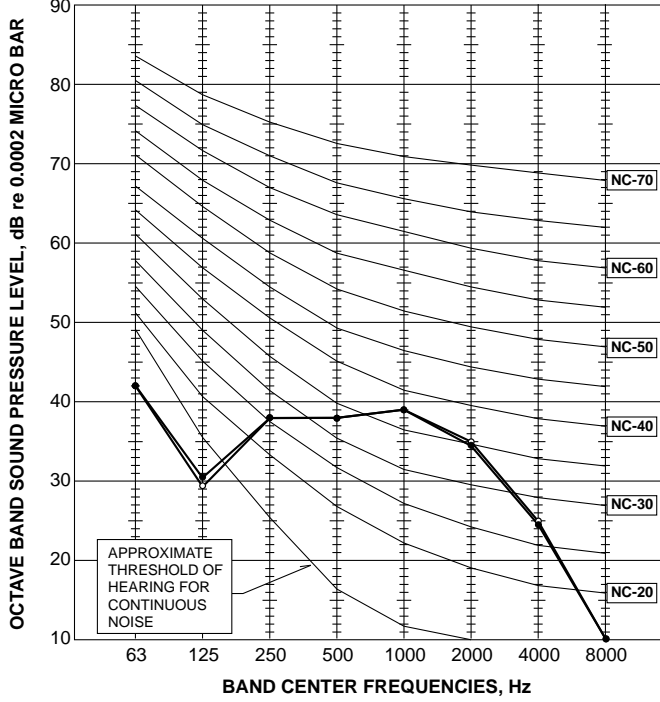

MSZ-FA35VA - [E1]

FAN SPEED	FUNCTION	SPL(dB(A))	LINE
Super High	COOLING	42	●—●
	HEATING	42	○—○

Test conditions,

Cooling : Dry-bulb temperature 27°C Wet-bulb temperature 19°C
 Heating : Dry-bulb temperature 20°C Wet-bulb temperature 15°C

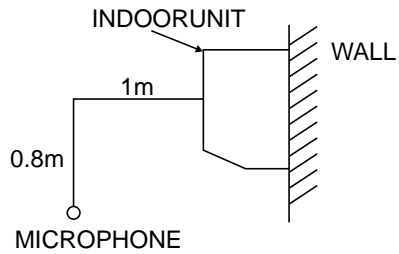
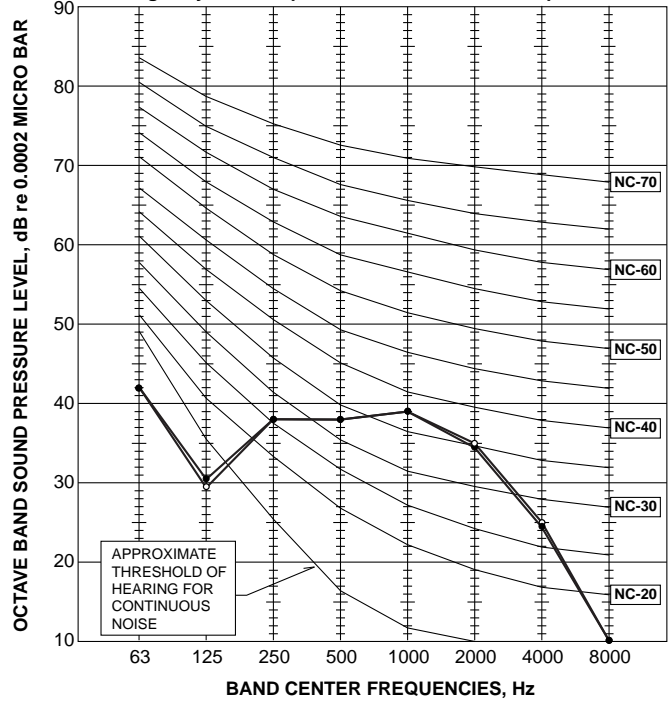

5

OUTLINES AND DIMENSIONS

MSZ-FA25VA -E1

MSZ-FA35VA -E1

Unit : mm

INDOOR UNIT

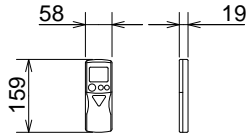
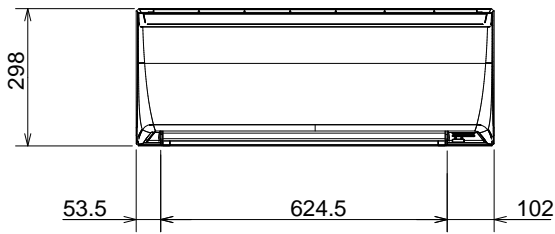
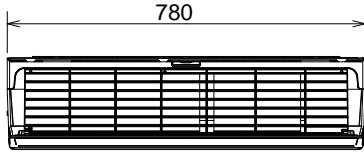

Wireless remote controller

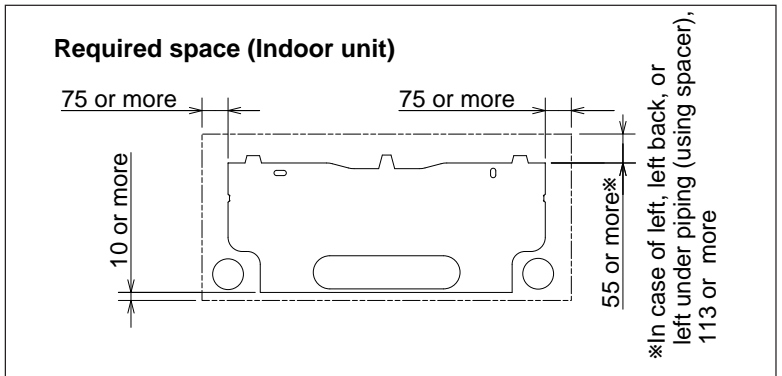
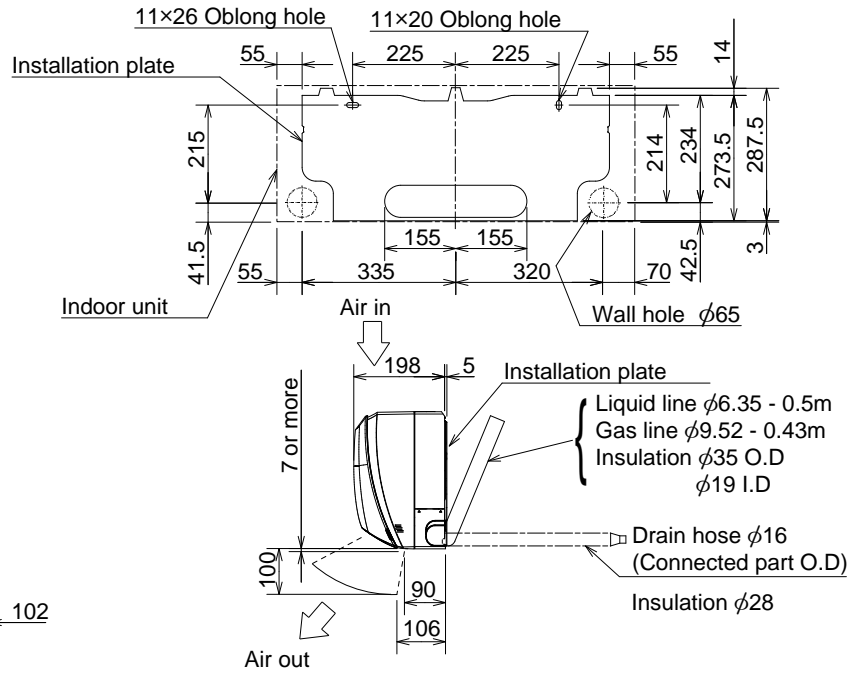

6 WIRING DIAGRAM

MSZ-FA25VA -[E1]

MSZ-FA35VA -[E1]

INDOOR UNIT

MODELS WIRING DIAGRAM

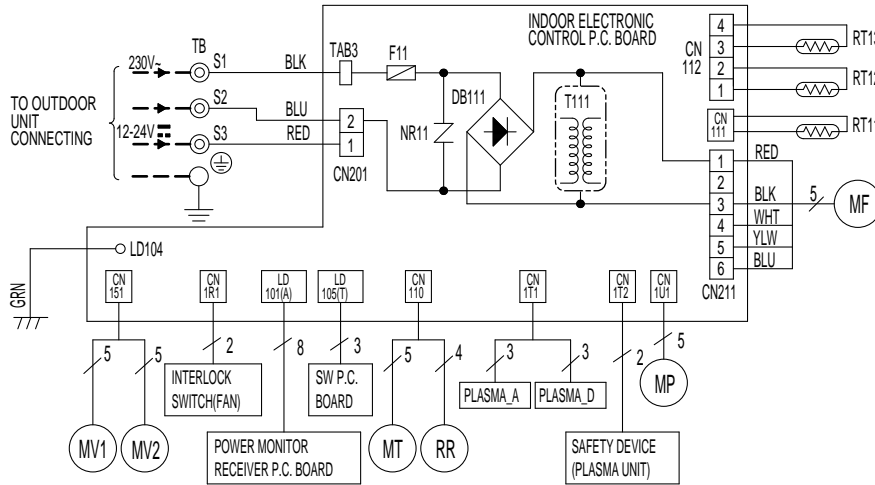

SYMBOL	NAME	SYMBOL	NAME	SYMBOL	NAME
DB111	DIODE STACK	MV2	VANE MOTOR (VERTICAL)	RT12	INDOOR COIL THERMISTOR (MAIN)
F11	FUSE (T3.15AL250V)	NR11	VARISTOR	RT13	INDOOR COIL THERMISTOR (SUB)
MF	INDOOR FAN MOTOR	PLASMA_A	PLASMA AIR PURIFYING FILTER UNIT	T111	TRANSFORMER
MP	FRONT PANEL DRIVING MOTOR	PLASMA_D	PLASMA DEODORIZING FILTER UNIT	TB	TERMINAL BLOCK
MT	i-see Sensor MOTOR	RR	i-see Sensor		
MV1	VANE MOTOR (HORIZONTAL)	RT11	ROOM TEMPERATURE THERMISTOR		

NOTE: 1. About the outdoor side electric wiring refer to the outdoor unit electric wiring diagram for servicing.
 2. Use copper conductors only. (For field wiring)
 3. Symbols below indicate.
 ○: Terminal block, □□□□: Connector

7 REFRIGERANT SYSTEM DIAGRAM

MSZ-FA25VA -[E1]

INDOOR UNIT

MSZ-FA35VA -[E1]

Unit : mm

INDOOR UNIT

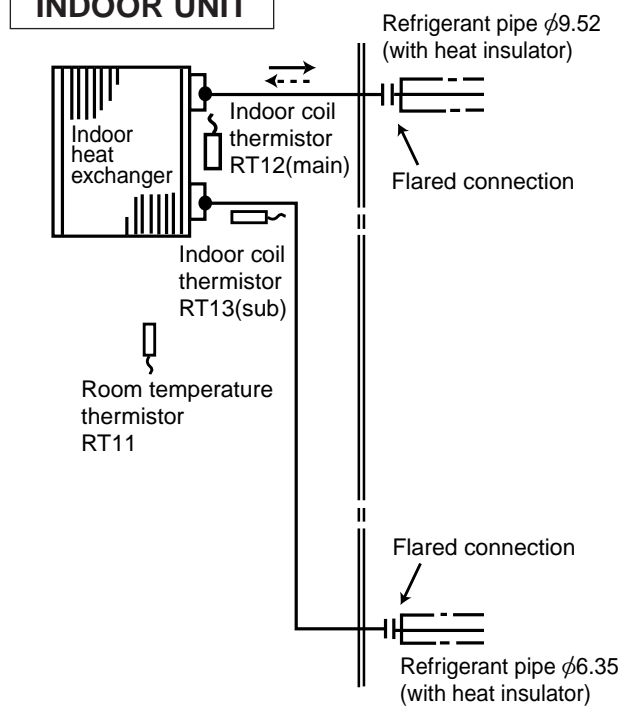
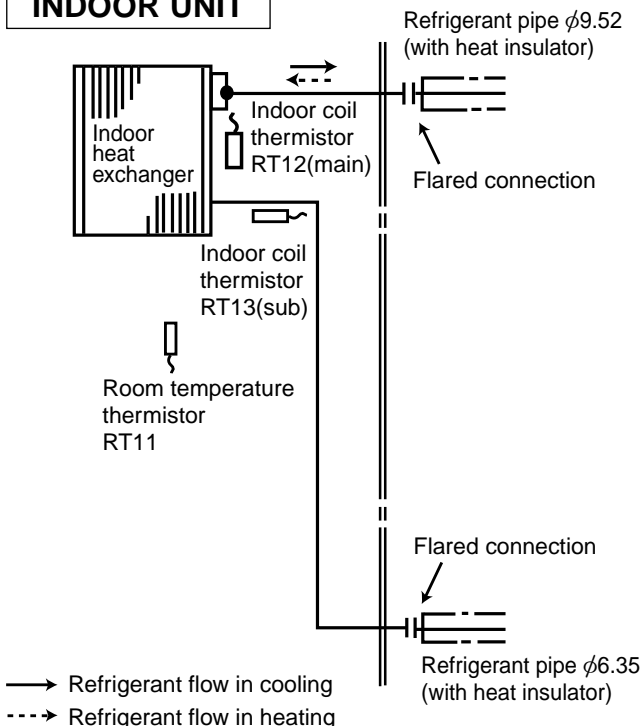

MSZ-FA25VA -[E1]

MSZ-FA35VA -[E1]

8-1. TIMER SHORT MODE

For service, set time can be shortened by short circuit of JPG and JPS the electronic control P.C. board.

The time will be shortened as follows. (Refer to 9-7.)

Set time : 1-minute → 1-second

Set time : 3-minute → 3-second (It takes 3 minutes for the compressor to start operation. However, the starting time is shortened by short circuit of JPG and JPS.)

8-2. P.C. BOARD MODIFICATION FOR INDIVIDUAL OPERATION

A maximum of 4 indoor units with wireless remote controllers can be used in a room.

In this case, to operate each indoor unit individually by each remote controller, P.C. boards of remote controller must be modified according to the number of the indoor unit.

How to modify the remote controller P.C. board

Remove batteries before modification.

The board has a print as shown below :

Remote controller model : KM05A

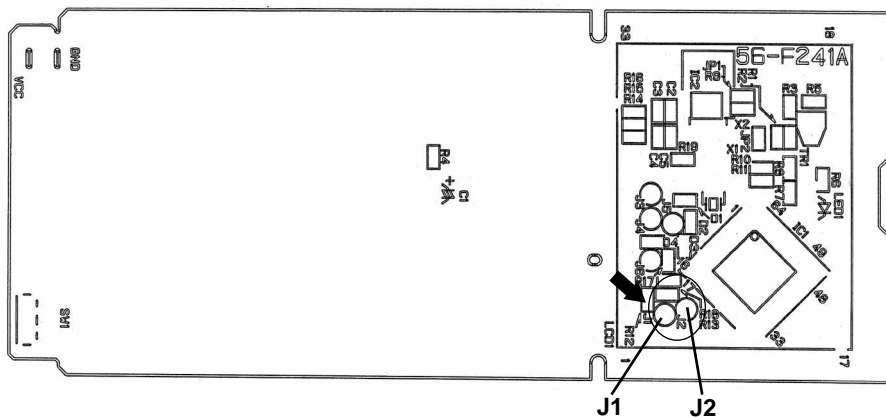

NOTE : For remodelling, take out the batteries and press the OPERATE/STOP(ON/OFF) button twice or 3 times at first.

After finish remodelling, put back the batteries then press the RESET button.

The P.C. board has the print "J1" and "J2". Solder "J1" and "J2" according to the number of indoor unit as shown in Table 1. After modification, press the RESET button.

Table 1

	1 unit operation	2 units operation	3 units operation	4 units operation
No. 1 unit	No modification	Same as at left	Same as at left	Same as at left
No. 2 unit	–	Solder J1	Same as at left	Same as at left
No. 3 unit	–	–	Solder J2	Same as at left
No. 4 unit	–	–	–	Solder both J1 and J2

How to set the remote controller exclusively for particular indoor unit.

After you turn the breaker ON, the first remote controller that sends the signal to the indoor unit will be regarded as the remote controller for the indoor unit.

The indoor unit will only accept the signal from the remote controller that has been assigned to the indoor unit once they are set.

The setting will be cancelled if the breaker has turned off, or the power supply has shut down.

Please conduct the above setting once again after the power has restored.

8-3. AUTO RESTART FUNCTION

When the indoor unit is controlled with the remote controller, the operation mode, the set temperature, and the fan speed are memorized by the indoor electronic control P.C. board. The "AUTO RESTART FUNCTION" sets to work the moment power has restored after power failure. Then, the unit will restart automatically.

Operation

- ① If the main power has been cut, the operation settings remain.
- ② After the power is restored, the unit restarts automatically according to the memory.
(However, it takes at least 3 minutes for the compressor to start running.)

How to release “AUTO RESTART FUNCTION”

- ① Turn off the main power for the unit.
- ② Solder the Jumper wire to JR07 on the indoor electronic control P.C. board. (Refer to 9-7.)

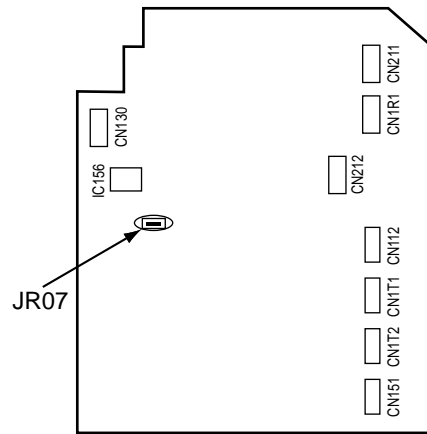

NOTE:

- The operation settings are memorized when 10 seconds have passed after the indoor unit was operated with the remote controller.
- If main power is turned OFF or a power failure occurs while AUTO START/STOP timer is active, the timer setting is cancelled.
- If the unit has been off with the remote controller before power failure, the auto restart function does not work as the power button of the remote controller is off.
- To prevent breaker off due to the rush of starting current, systematize other home appliance not to turn on at the same time.
- When some air conditioners are connected to the same supply system, if they are operated before power failure, the starting current of all the compressors may flow simultaneously at restart. Therefore, the special counter-measures are required to prevent the main voltage-drop or the rush of the starting current by adding to the system that allows the units to start one by one.

8-4. Remote controller

Be sure to set the slide switch inside the remote controller to an appropriate position in accordance with the installed position of the indoor unit. If the switch is not set correctly, the air conditioner may not function properly.

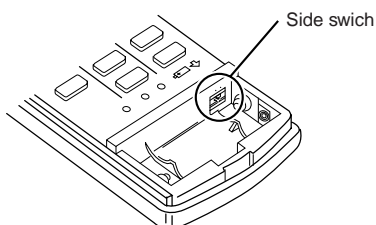

Area	Left	Center	Right
Position of the slide switch	L . C . R	L . C . R	L . C . R
Display on the remote controller			

Where is the indoor unit installed in your room?

Installed at left , if the distance is not more than 50 cm.

Installed at right , if the distance is not more than 50 cm.

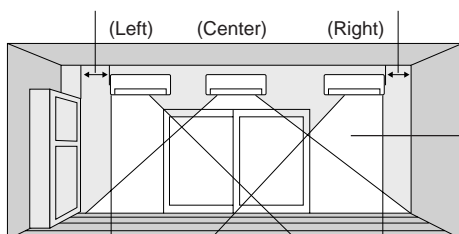

NOTE: If the indoor unit is installed more than 50 cm away from the side walls, cabinets or other nearby objects, set the slide switch to the “center” position.

MSZ-FA25VA -[E1]

MSZ-FA35VA -[E1]

9-1. Cautions on troubleshooting**1. Before troubleshooting, check the following:**

- 1) Check the power supply voltage.
- 2) Check the indoor/outdoor connecting wire for mis-wiring.

2. Take care the following during servicing.

- 1) Before servicing the air conditioner, be sure to turn off the unit first with the remote controller, and then after confirming the horizontal vane is closed, turn off the breaker and / or disconnect the power plug.
- 2) Be sure to turn OFF the power supply before removing the front panel, the cabinet, the top panel, and the electronic control P.C. board.
- 3) When removing the electronic control P.C. board, hold the edge of the board with care NOT to apply stress on the components.
- 4) When connecting or disconnecting the connectors, hold the housing of the connector. DO NOT pull the lead wires.

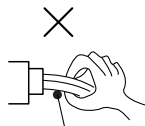

Lead wiring

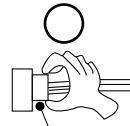

Housing point

3. Troubleshooting procedure

- 1) First, check if the OPERATION INDICATOR lamp on the indoor unit is flashing on and off to indicate an abnormality. To make sure, check how many times the abnormality indication is flashing on and off before starting service work.
- 2) Before servicing check that the connector and terminal are connected properly.
- 3) If the electronic control P.C. board is supposed to be defective, check the copper foil pattern for disconnection and the components for bursting and discoloration.
- 4) When troubleshooting, refer to 9-2., 9-3. and 9-4.

4. How to replace batteries

Weak batteries may cause the remote controller malfunction.

In this case, replace the batteries to operate the remote controller normally.

- ① Remove the front lid and insert batteries. Then reattach the front lid.

- ② Press RESET button with tip end of ball point pen or the like, and then use the remote controller.

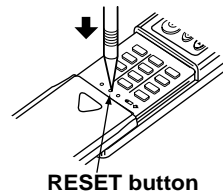
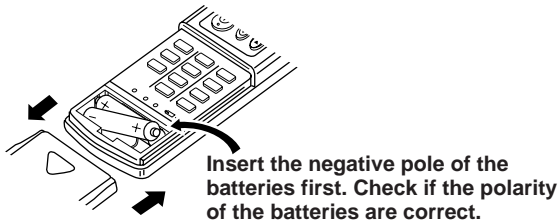

NOTE : 1. If RESET button is not pressed, the remote controller may not operate correctly.

2. This remote controller has a circuit to automatically reset the microcomputer when batteries are replaced. This function is equipped to prevent the microcomputer from malfunctioning due to the voltage drop caused by the battery replacement.

5. How to install the horizontal vane

If horizontal vane is not installed correctly, All of the operation indicator lamps will blink.

In this case, install the horizontal vane correctly by following the procedures ① to ②.

NOTE: Before installation of the horizontal vane, turn OFF the power supply.

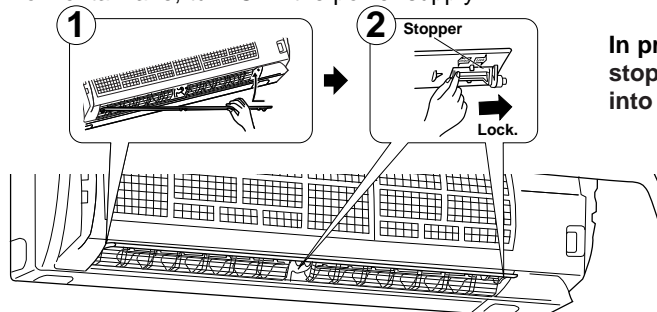
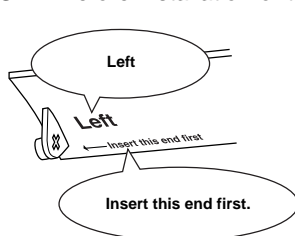

6. How to remove and install PLASMA DEODORIZING / AIR PURIFYING filter units

If PLASMA/WASH lamp on the indoor unit blinks, clean the filters as soon as possible. The lamp will start blinking when accumulated operating time exceeds 330 hours.

<Remove>

- (1) Switch the indoor unit OFF with the remote controller and disconnect the power supply plug and/ or turn OFF the breaker.

NOTE: Otherwise, you may get injured since PLASMA DEODORIZING/AIR PURIFYING filter units are charged with high voltage.

- (2) Hold the knobs on both sides of the front panel and lift the panel up until its level.
- (3) Remove the anti-mold air filter.(See Figure 1.)
- (4) Remove PLASMA DEODORIZING/AIR PURIFYING filter units. (See Figure 2.)

Figure 1.

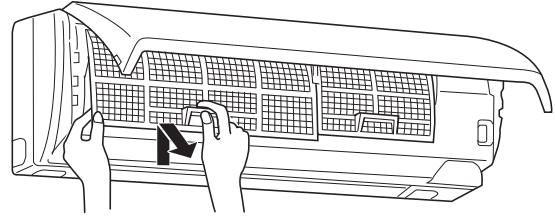
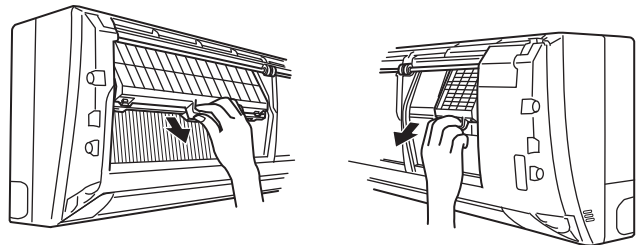

Figure 2.



<Install>

Install PLASMA DEODORIZING/AIR PURIFYING filter units by following the removal procedure in reverse.

- (1) Insert the top of PLASMA DEODORIZING/AIR PURIFYING filter units into the aperture in the plasma element holder. (See Figure 3.)
- (2) Push in PLASMA DEODORIZING/AIR PURIFYING filter units until they click into place.
 - The front panel does not close if PLASMA DEODORIZING/AIR PURIFYING filter units are not installed properly.
- (3) Install the anti-mold air filter.
- (4) Connect the power supply plug and/ or turn ON the breaker.
- (5) Press WASH reset switch. A short “beep” is heard and the blinks of PLASMA/WASH lamp will be cancelled. Make sure PLASMA/WASH lamp is not blinking at the start of operation next time. (See Figure 4.)
- (6) Hold both sides of the front panel and close the front panel.
- (7) Press the 3 positions on the front panel as indicated by the arrows.(See Figure 5.)

Figure 3.

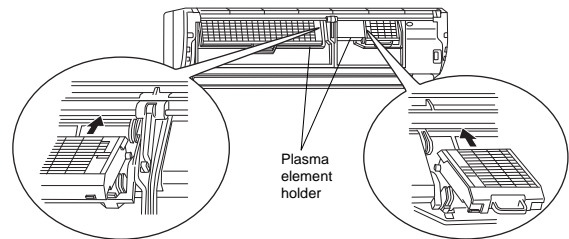

Figure 4.

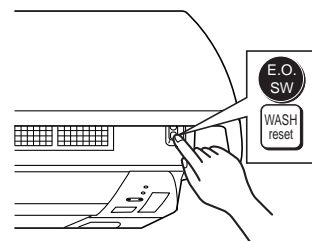
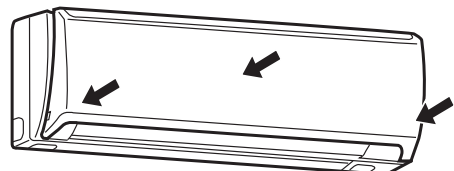

Figure 5.



NOTE:

Install PLASMA DEODORIZING/AIR PURIFYING filter units only when they are completely dry. If the filter unit remains wet, PLASMA/WASH lamp may blink and the plasma function may be disabled.(When PLASMA DEODORIZING/AIR PURIFYING filter units are cleaned.)

**INFORMATION FOR MULTI SYSTEM AIR CONDITIONER
OUTDOOR UNIT : MXZ series**

Multi system air conditioner can connect two or more indoor units with one outdoor unit.

- Unit won't operate in case the total capacity of indoor units exceeds the capacity of outdoor units. Do not connect indoor units beyond the outdoor unit capacity.

Operation indicator lamp flashes as shown in the figure below.

- When you try to operate two or more indoor units with one outdoor unit simultaneously, one for the cooling and the other for heating, the operation mode of the indoor unit that operates earlier is selected. The other indoor units which start the operation later cannot operate, indicating as shown in the figure below. In this case, please set all the indoor units to the same operation mode.

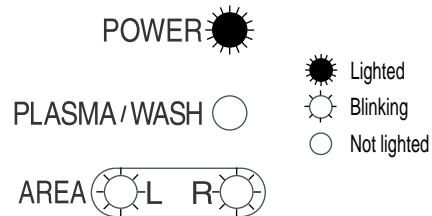

- When indoor units start the operation while the defrosting of outdoor unit is being done, it takes a few minutes (max. 10 minutes) to blow out the warm air.
- In the heating operation, though indoor unit that does not operate may get warm or the sound of refrigerant flowing may be heard, they are not malfunction. The reason is that the refrigerant continuously flows into it.

9-2. Failure mode recall function

Outline of the function

This air conditioner can memorize the abnormal condition which has occurred once.

Even though LED indication listed on the troubleshooting check table disappears, the memorized failure details can be recalled.

This mode is very useful when the unit needs to be repaired for the abnormality which doesn't recur.

1. Flow chart of the indoor/outdoor unit failure mode recall function

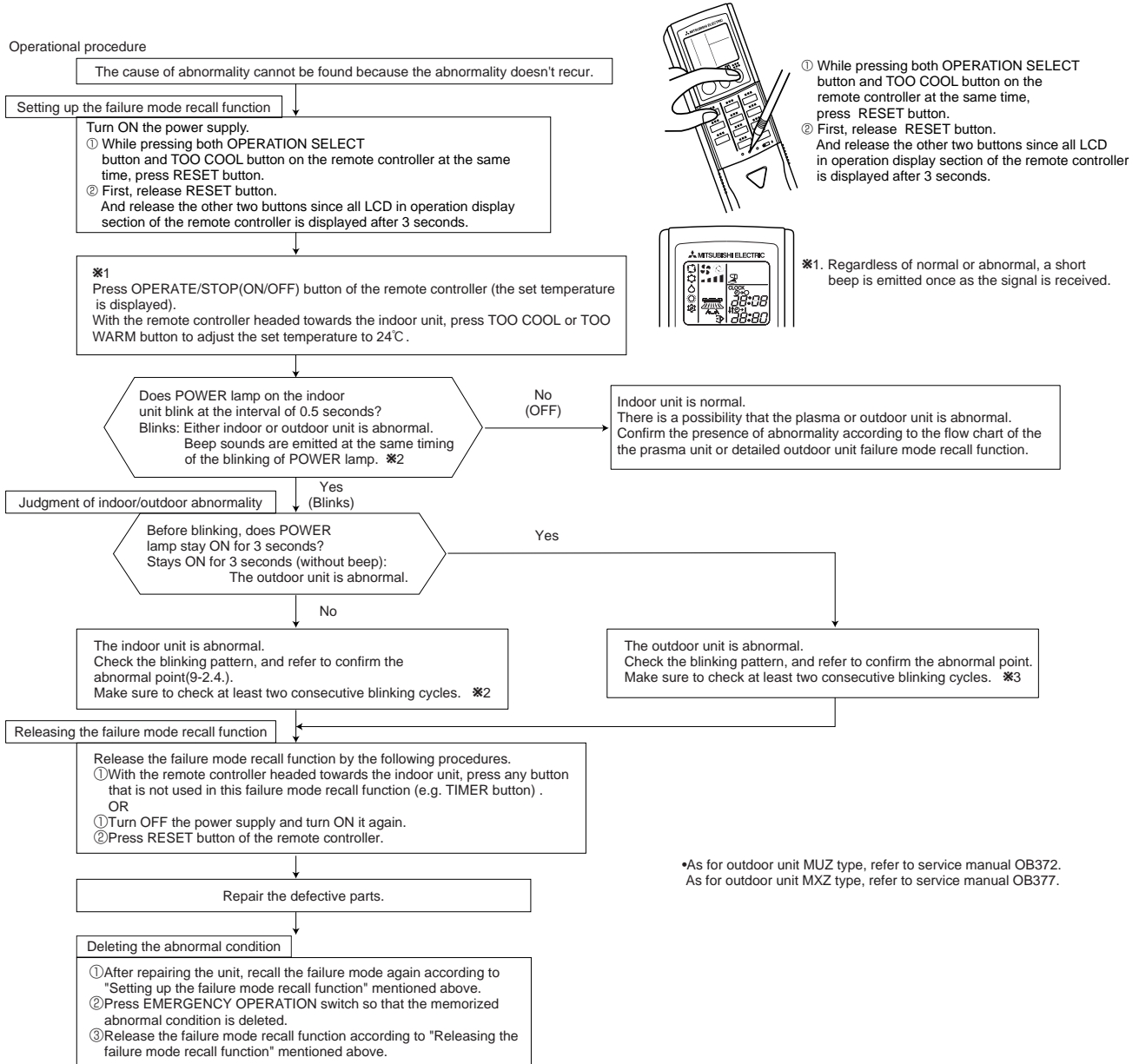

Note1. Make sure to release the failure mode recall function once it's set up, otherwise the unit cannot operate properly.
 2. If the abnormal condition is not deleted from the memory, the last abnormal condition is kept memorized.

※2. Blinking pattern when the indoor unit is abnormal:

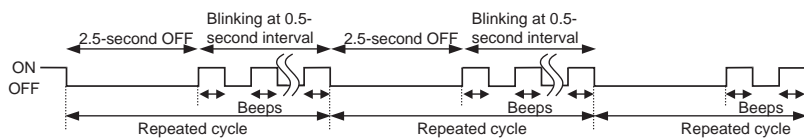

※3. Blinking pattern when the outdoor unit is abnormal:

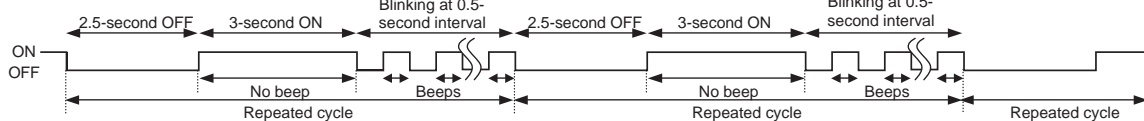

2. Flow chart of PLASMA DEODORIZING/PLASMA AIR PURIFYING power failure mode recall function

Operational procedure

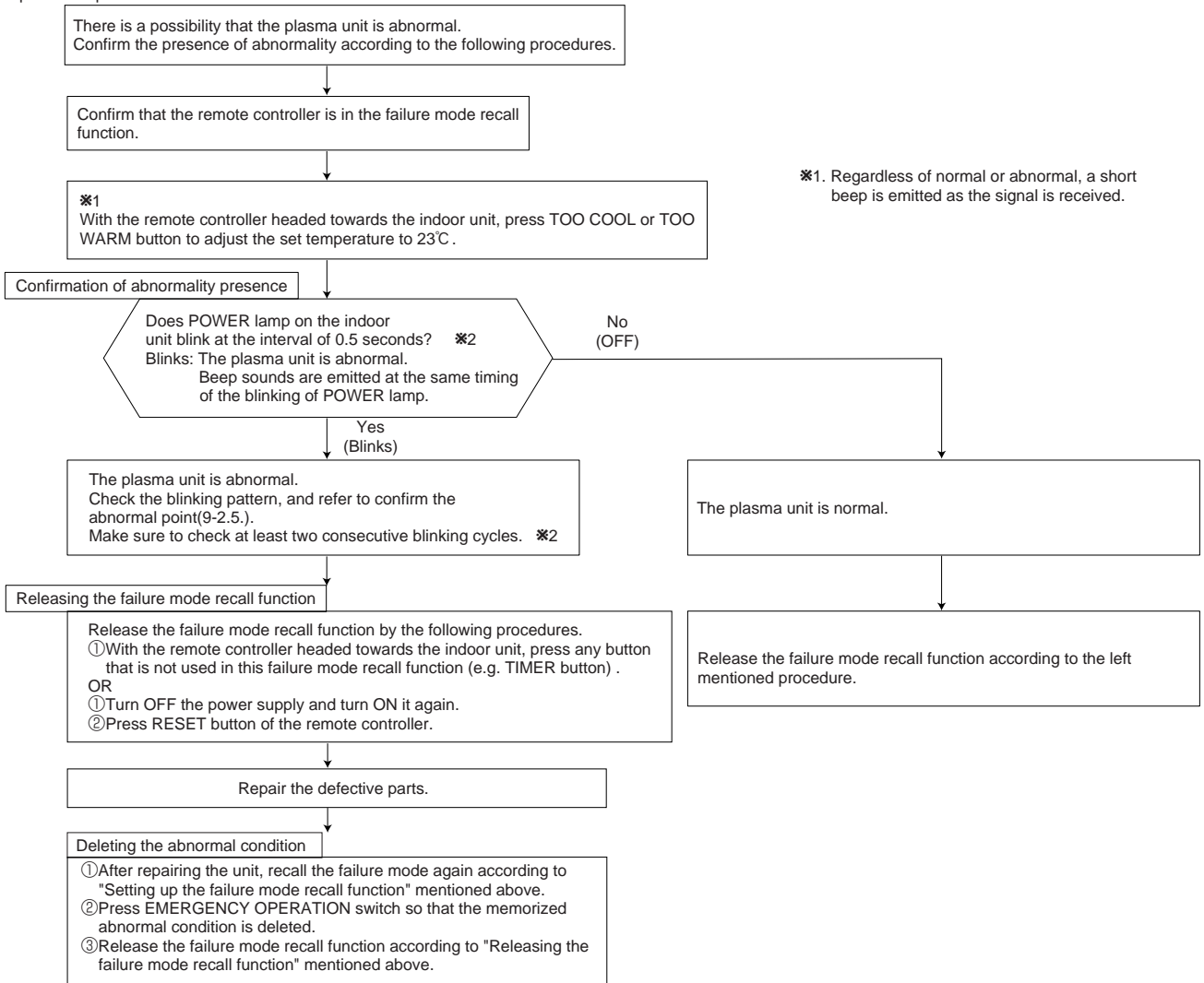

Note1. Make sure to release the failure mode recall function once it's set up, otherwise the unit cannot operate properly.
2. If the abnormal condition is not deleted from the memory, the last abnormal condition is kept memorized.

*2.Blinking pattern when outdoor unit is abnormal:

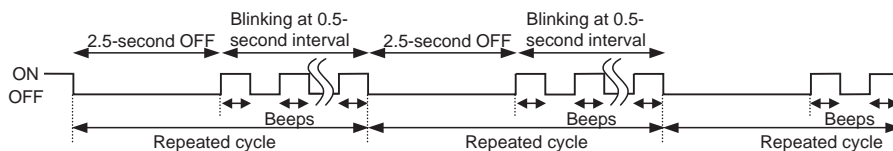

3. PLASMA DEODORIZING/PLASMA AIR PURIFYING power operation check

PLASMA DEODORIZING/PLASMA AIR PURIFYING power goes ON when PLASMA button on the remote controller is pressed once while the indoor error indication is being checked or after one short beep sound (signal reception beep) is emitted.

PLASMA button is pressed, the power of plasma is changed in sequence:

PLASMA DEODORIZING power goes ON $\text{ON} \rightarrow \text{PLASMA AIR PURIFYING}$ power goes ON $\text{ON} \rightarrow \text{Cancel}$

Check the operation display section of the remote controller to confirm that PLASMA DEODORIZING power or PLASMA AIR PURIFYING power is activated.

While PLASMA/WASH lamp stays OFF, and it means normal.

Flashing PLASMA/WASH lamp means abnormal, and the plasma power is not being conducted.

PLASMA/WASH lamp	Action
Continuously flashes	Follow "Check of PLASMA DEODORIZING power" or "Check of PLASMA AIR PURIFYING power" to identify the error.(Refer to 9-6.Ⓕ or Ⓖ.)
2-time flash	PLASMA DEODORIZING power or PLASMA AIR PURIFYING power control circuit on the indoor electronic control P.C. board is out of order.(Refer to 9-6.Ⓕ or Ⓖ.)

NOTE: Perform the above mentioned check with the front panel closed. Panel open is detected by the SAFETY DEVICE (PLASMA UNIT).

4. Indoor unit failure mode table

NOTE: Blinking patterns of this mode differs from the ones of Troubleshooting check table(9-4.).

POWER lamp	Abnormal point (Failure mode)	Detection method	Check point
Not lighted	Normal	—	—
1-time flash every 0.5-second	Room temperature thermistor	When the room temperature thermistor short or open circuit is detected every 8 seconds during operation.	Refer to the characteristics of the room temperature thermistor (9-7.).
2-time flash 2.5-second OFF	Indoor coil thermistor	When the indoor coil thermistor short or open circuit is detected every 8 seconds during operation.	Refer to the characteristic of the main indoor coil thermistor, the sub indoor coil thermistor (9-7.).
3-time flash 2.5-second OFF	Serial signal error	When the serial signal from outdoor unit is not received for a maximum of 6 minutes.	Refer to 9-6.⑩ "How to check miswiring and serial signal error".
11-time flash 2.5-second OFF	Indoor fan motor	When the rotational frequency feedback signal is not emit during 12-second the indoor fan operation.	Refer to 9-6.④ "Check of indoor fan motor".
12-time flash 2.5-second OFF	Indoor control system	When it cannot properly read data in the nonvolatile memory of the indoor electronic control P.C. board.	Replace the indoor electronic control P.C. board.

5. PLASMA DEODORIZING/PLASMA AIR PURIFYING power failure mode table

POWER lamp	Abnormal point (Failure mode)	Detection method	Check point
1-time flash	PLASMA DEODORIZING/PLASMA AIR PURIFYING power control	When PLASMA DEODORIZING/PLASMA AIR PURIFYING power cannot be turned OFF.	Replace the indoor electronic control P.C. board.
2-time flash	Spark discharge	When the voltage between CN1 ①(+) and ②(GND) on the PLASMA POWER P.C. board (PLASMA DEODORIZING or PLASMA AIR PURIFYING) falls below 1.6V(spark discharge judgment voltage).	Refer to 9-6.⑤"Check of PLASMA DEODORIZING power" or 9-6.⑥"Check of PLASMA AIR PURIFYING power".
3-time flash	Abnormal electric discharge error 1	When the voltage between CN1 ①(+) and ②(GND) on the PLASMA POWER P.C. board (PLASMA DEODORIZING or PLASMA AIR PURIFYING) falls 0.9V below the normal range voltage.	Refer to 9-6.⑤"Check of PLASMA DEODORIZING power" or 9-6.⑥"Check of PLASMA AIR PURIFYING power".
4-time flash	Abnormal electric discharge error 2	When the voltage between CN1 ①(+) and ②(GND) on the PLASMA POWER P.C. board (PLASMA DEODORIZING or PLASMA AIR PURIFYING) falls significantly. (0.4V / 0.5ms)	Refer to 9-6.⑤"Check of PLASMA DEODORIZING power" or 9-6.⑥"Check of PLASMA AIR PURIFYING power".
5-time flash	PLASMA DEODORIZING/PLASMA AIR PURIFYING power	When the voltage between CN1 ①(+) and ②(GND) on the PLASMA POWER P.C. board (PLASMA DEODORIZING or PLASMA AIR PURIFYING) rises above the normal voltage value (3V).	Refer to 9-6.⑤"Check of PLASMA DEODORIZING power" or 9-6.⑥"Check of PLASMA AIR PURIFYING power".

※ As soon as an error is detected, PLASMA DEODORIZING power or PLASMA AIR PURIFYING power goes OFF, therefore measuring instrument which records the voltage wave is required in order to perform the above mentioned voltage measurement.

9-3. Instruction of troubleshooting

*"Test Run operation" means the operation within 30 minutes after EMERGENCY OPERATION switch is pressed.

If blinking of OPERATION INDICATOR lamp cannot be checked, it can be checked with failure mode recall function.

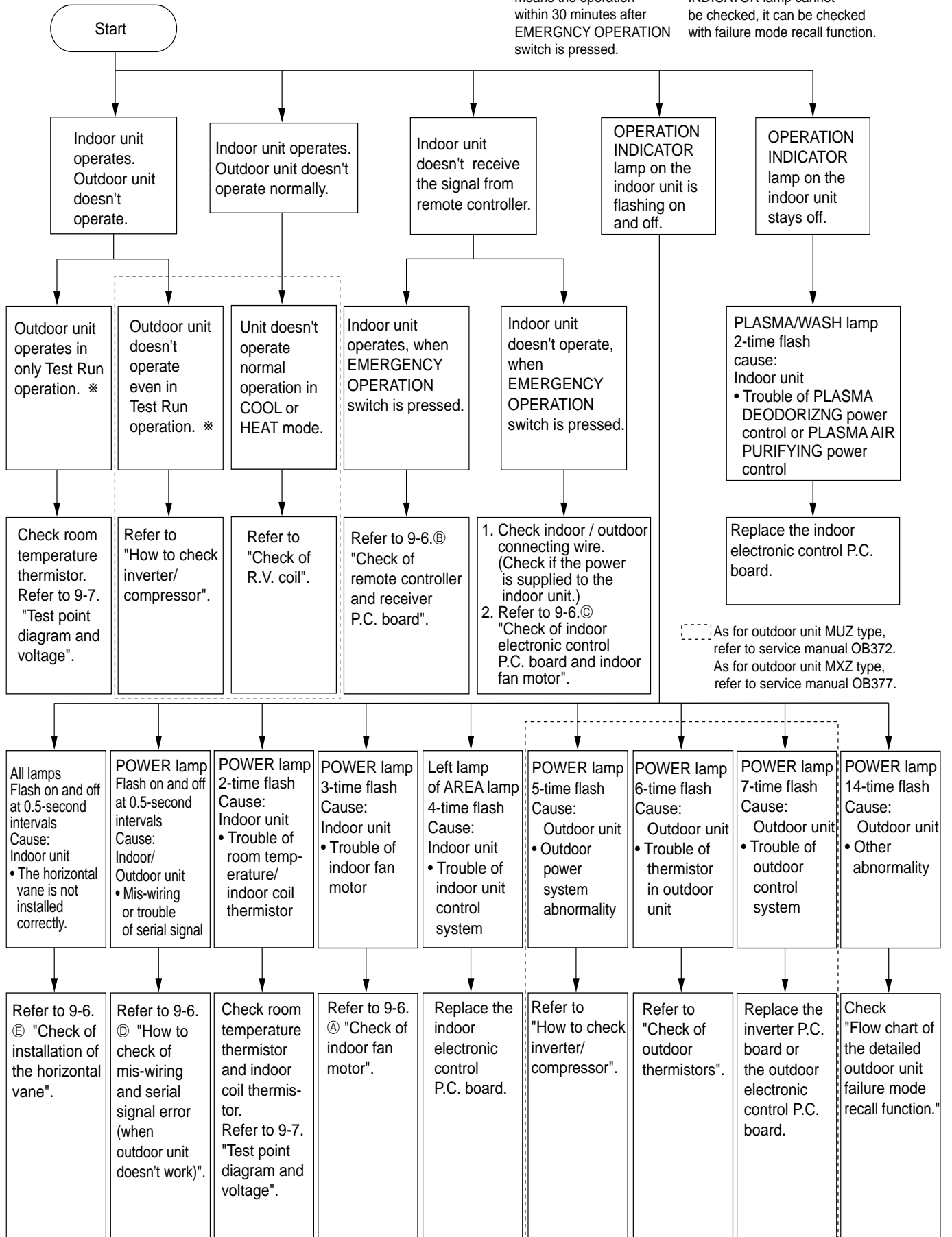



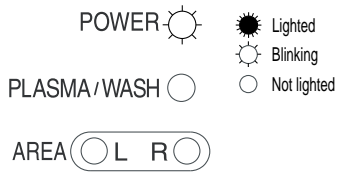



































































9-4. Troubleshooting check table



· Flashing of POWER lamp indicates abnormalities.

NOTE : Before taking measures, make sure that the symptom reappears for accurate troubleshooting.
 Self check table

No.	Abnormal point	Operation indicator lamp	Symptom	Detection method	Check point
1	Mis-Wiring or serial signal	POWER lamp flashes. 0.5-second ON      0.5-second OFF	Outdoor unit does not operate.	When the serial signal from the outdoor unit is not received for a maximum of 6 minutes.	• Refer to 9-6.⑥ "How to check mis-wiring and serial signal error".
2	Outdoor control system	POWER lamp lights up 	Outdoor unit does not operate.	When it cannot properly read data in the nonvolatile memory of the inverter P.C. board or the outdoor electronic control P.C. board.	• Check the blinking pattern of the LED on the inverter P.C. board or the outdoor electronic control P.C. board.
3	Indoor coil thermistor Room temperature thermistor	POWER lamp flashes. 2-time flash          2.5-second OFF	Indoor unit and outdoor unit do not operate.	When the indoor coil or the room temperature thermistor is short or open circuit.	• Refer to 9-7.the characteristics of indoor coil thermistor, and the room temperature thermistor.
4	Indoor fan motor	POWER lamp flashes. 3-time flash          2.5-second OFF	Indoor unit and outdoor unit do not operate.	When the rotational frequency feedback signal is not emit during the indoor fan operation.	• Refer to 9-7.⑧ "Check of indoor fan motor".
5	Outdoor power system	POWER lamp flashes. 5-time flash          2.5-second OFF	Indoor unit and outdoor unit do not operate.	When it consecutively occurs 3 times that the compressor stops for overcurrent protection or start-up failure protection with in 1 minute after start-up.	• Refer to "Check of inverter/compressor". Refer to service manual OB372 or OB377. Check the stop valve.
6	Outdoor thermistors	POWER lamp flashes. 6-time flash          2.5-second OFF	Indoor unit and outdoor unit do not operate.	When the outdoor thermistors short or open circuit during the compressor operation.	• Refer to "Check of outdoor thermistor". Refer to service manual OB372 or OB377.
7	Outdoor control system	POWER lamp flashes. 7-time flash          2.5-second OFF	Indoor unit and outdoor unit do not operate.	When it cannot properly read data in the nonvolatile memory of the inverter P.C. board or the outdoor electronic control P.C. board.	• Replace the inverter P.C. board or the outdoor electronic control P.C. board. Refer to service manual OB372 or OB377.
8	Other abnormality	POWER lamp flashes. 14-time flash                    2.5-second OFF	Indoor unit and outdoor unit do not operate.	An abnormality other than above mentioned is detected.	• Confirm the abnormality in detail using the failure mode recall function.

NOTE : When the indoor unit has started operation and the above detection method has detected an abnormality (the first detection after the power ON), the indoor electronic control P.C. board turns OFF the indoor fan motor with OPERATION INDICATOR lamp flashing.

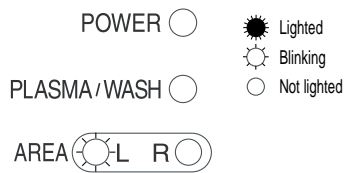

· Flashing of AREA lamp(left-hand side lamp) indicates abnormality.

NOTE : Before taking measures, make sure that the symptom reappears for accurate troubleshooting.
 Self check table

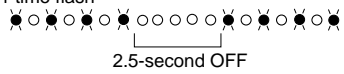
No.	Abnormal point	Operation indicator lamp	Symptom	Detection method	Check point
1	Indoor control system	Left lamp of AREA lamp flashes. 4-time flash  2.5-second OFF	Indoor unit and outdoor unit do not operate.	When it cannot properly read data in the nonvolatile memory of the indoor electronic control P.C. board.	• Replace the indoor electronic control P.C. board.

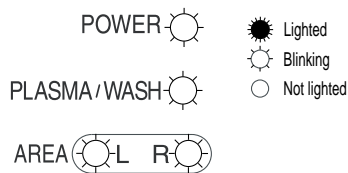

· Flashing of All lamps indicate abnormality.

No.	Abnormal point	Operation indicator lamp	Symptom	Detection method	Check point
1	Attachment of the horizontal vane	All lamps flash at the same time. 0.5-second ON  0.5-second OFF	Indoor unit and outdoor unit do not operate.	When the electricity is not conducted to the interlock switch (Fan) of the horizontal vane.	• Refer to 9-6.⑥ "Check of installation of the horizontal vane".

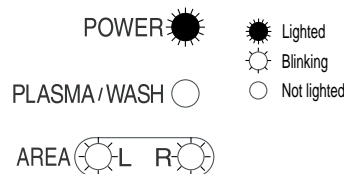

· Flashing of AREA lamp(both lamps) indicates abnormality.
 · POWER lamp is lighted.

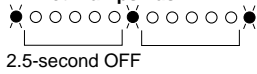
No.	Abnormal point	Operation indicator lamp	Symptom	Detection method	Check point
1	MXZ type Operation mode setting	Both lamps flash  2.5-second OFF	Outdoor unit operates but indoor unit does not operate.	When the operation mode of the each indoor unit is differently set to COOL(includes DRY) and HEAT at the same time, the operation mode of the indoor unit that has operated at first has the priority.	• Unify the operation mode. Refer to service manual OB377.

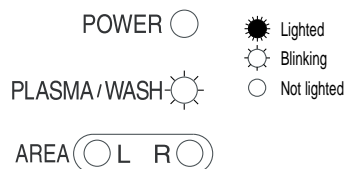

· Flashing of PLASMA/WASH lamp indicates abnormality.

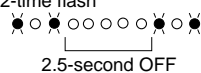
No.	Abnormal point	Operation indicator lamp	Symptom	Detection method	Check point
1	PLASMA DEODORIZING/ PLASMA AIR PURIFYING power control	PLASMA/WASH lamp flashes. 2-time flash  2.5-second OFF	Indoor unit and outdoor unit do not operate.	When PLASMA DEODORIZING power or PLASMA AIR PURIFYING power can not be turned OFF.	• Replace the indoor electronic control P.C. board.

NOTE : When the indoor unit has started operation and the above detection method has detected an abnormality (the first detection after the power ON), the indoor electronic control P.C. board turns OFF the indoor fan motor with OPERATION INDICATOR lamp flashing.

9-5. Trouble criterion of main parts

MSZ-FA25VA -[E1] MSZ-FA35VA -[E1]

Part name	Check method and criterion	Figure									
Room temperature thermistor(RT11)	Measure the resistance with a tester. (Part temperature 10°C ~ 30°C)										
Indoor coil thermistor (RT12(MAIN), RT13(SUB))											
	<table border="1"> <thead> <tr> <th></th> <th>Normal</th> <th>Abnormal</th> </tr> </thead> <tbody> <tr> <td></td> <td>8 kΩ ~ 20 kΩ</td> <td>Open or short-circuit</td> </tr> </tbody> </table>		Normal	Abnormal		8 kΩ ~ 20 kΩ	Open or short-circuit				
	Normal	Abnormal									
	8 kΩ ~ 20 kΩ	Open or short-circuit									
Indoor fan motor(MF)	Check 9-6. ㉞.										
Horizontal vane motor(MV1)	Measure the resistance between the terminals with a tester. (Part temperature 10°C ~ 30°C)										
	<table border="1"> <thead> <tr> <th>Color of the lead wire</th> <th>Normal</th> <th>Abnormal</th> </tr> </thead> <tbody> <tr> <td>BRN-other one</td> <td>235 Ω ~ 255 Ω</td> <td>Open or short-circuit</td> </tr> </tbody> </table>		Color of the lead wire	Normal	Abnormal	BRN-other one	235 Ω ~ 255 Ω	Open or short-circuit			
Color of the lead wire	Normal	Abnormal									
BRN-other one	235 Ω ~ 255 Ω	Open or short-circuit									
Vertical vane motor(MV2) i-see Sensor motor(MT)	Measure the resistance between the terminals with a tester. (Part temperature 10°C ~ 30°C)										
	<table border="1"> <thead> <tr> <th>Color of the lead wire</th> <th>Normal</th> <th>Abnormal</th> </tr> </thead> <tbody> <tr> <td>BRN-other one</td> <td>282 Ω ~ 306 Ω</td> <td>Open or short-circuit</td> </tr> </tbody> </table>		Color of the lead wire	Normal	Abnormal	BRN-other one	282 Ω ~ 306 Ω	Open or short-circuit			
Color of the lead wire	Normal	Abnormal									
BRN-other one	282 Ω ~ 306 Ω	Open or short-circuit									
Front panel driving motor (MP)	Measure the resistance between the terminals with a tester. (Part temperature 10°C ~ 30°C)										
	<table border="1"> <thead> <tr> <th>Color of the lead wire</th> <th>Normal</th> <th>Abnormal</th> </tr> </thead> <tbody> <tr> <td>BRN-other one</td> <td>94 Ω ~ 102 Ω</td> <td>Open or short-circuit</td> </tr> </tbody> </table>		Color of the lead wire	Normal	Abnormal	BRN-other one	94 Ω ~ 102 Ω	Open or short-circuit			
Color of the lead wire	Normal	Abnormal									
BRN-other one	94 Ω ~ 102 Ω	Open or short-circuit									
i-see Sensor(RR)	<p>Turn the power ON(i-see Sensor is energized) with the aluminum block part on the i-see Sensor P.C. board (upper part of i-see Sensor) covered with black vinyl tape, then measure the voltage between connector terminals of i-see Sensor using tester. (Part temperature 10 ~ 40°C)</p> <p>※ The aluminum block part is covered with black vinyl tape.</p> <table border="1"> <thead> <tr> <th>i-see Sensor connector terminals</th> <th>Normal range</th> <th>Abnormal</th> </tr> </thead> <tbody> <tr> <td>②(-) - ④(+)</td> <td>1.874 ~ 3.387V DC</td> <td>Below 1.874 or above 3.387V DC</td> </tr> <tr> <td>①(+) - ②(-)</td> <td>1.010 ~ 1.420V DC</td> <td>Below 1.010 or above 1.420V DC</td> </tr> </tbody> </table> <p>NOTE: Pay attention to static electricity.</p>	i-see Sensor connector terminals	Normal range	Abnormal	②(-) - ④(+)	1.874 ~ 3.387V DC	Below 1.874 or above 3.387V DC	①(+) - ②(-)	1.010 ~ 1.420V DC	Below 1.010 or above 1.420V DC	
i-see Sensor connector terminals	Normal range	Abnormal									
②(-) - ④(+)	1.874 ~ 3.387V DC	Below 1.874 or above 3.387V DC									
①(+) - ②(-)	1.010 ~ 1.420V DC	Below 1.010 or above 1.420V DC									
PLASMA DEODORIZING/ PLASMA AIR PURIFYING power	Check 9-6. ㉟ or ㊱.										

9-6. Troubleshooting flow

When POWER lamp flashes 3-time.
Indoor fan does not operate.

(A) Check of indoor fan motor

The indoor fan motor error has occurred, and the indoor fan doesn't operate.

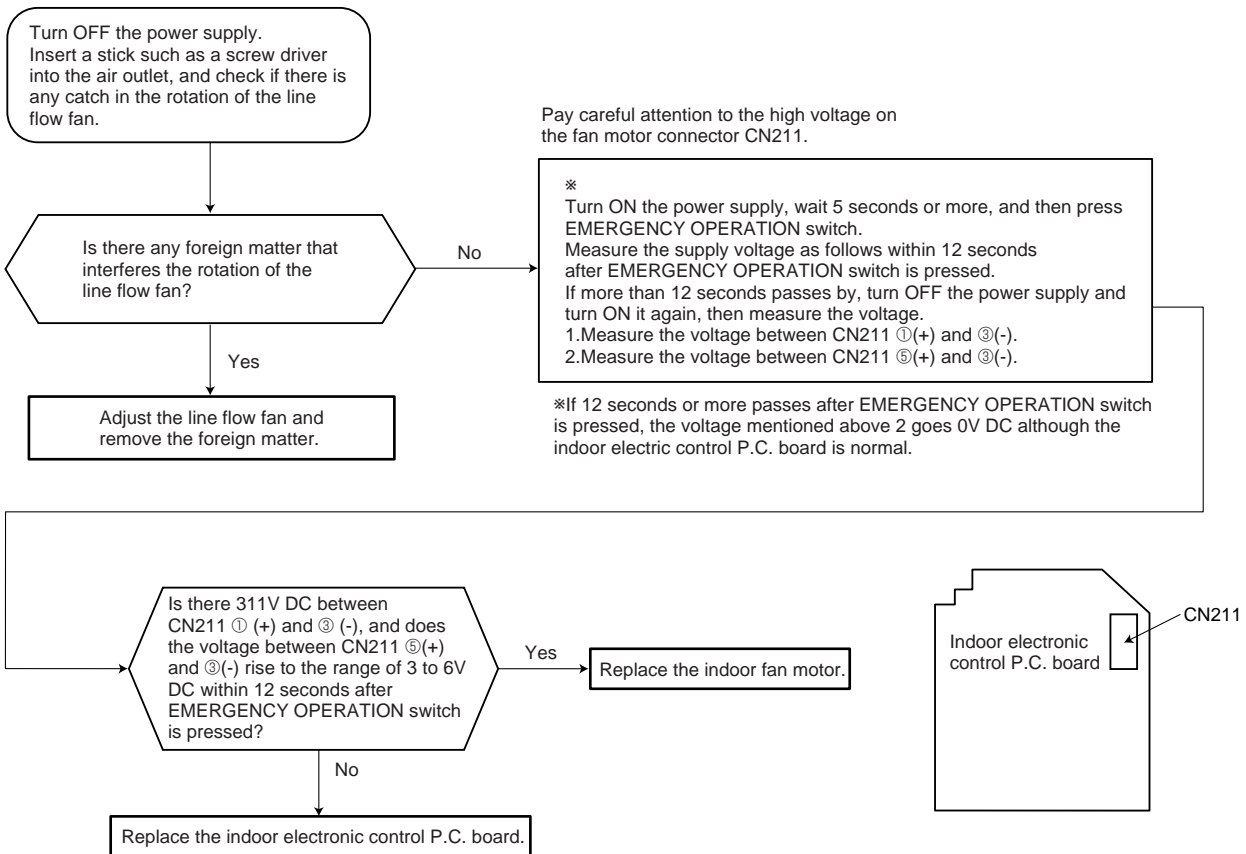

The indoor fan motor error has occurred, and the indoor fan repeats "12-second ON and 30-second OFF" 3 times, and then stops.

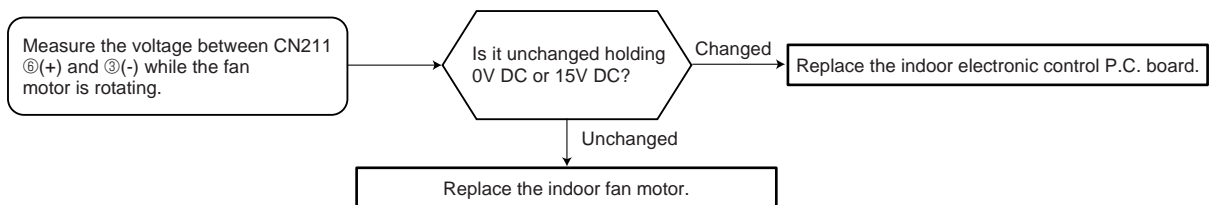

Indoor unit operates by pressing EMERGENCY OPERATION switch, but does not operate with the remote controller.

Ⓑ Check of remote controller and receiver P.C. board

※Check if the remote controller is exclusive for this air conditioner.

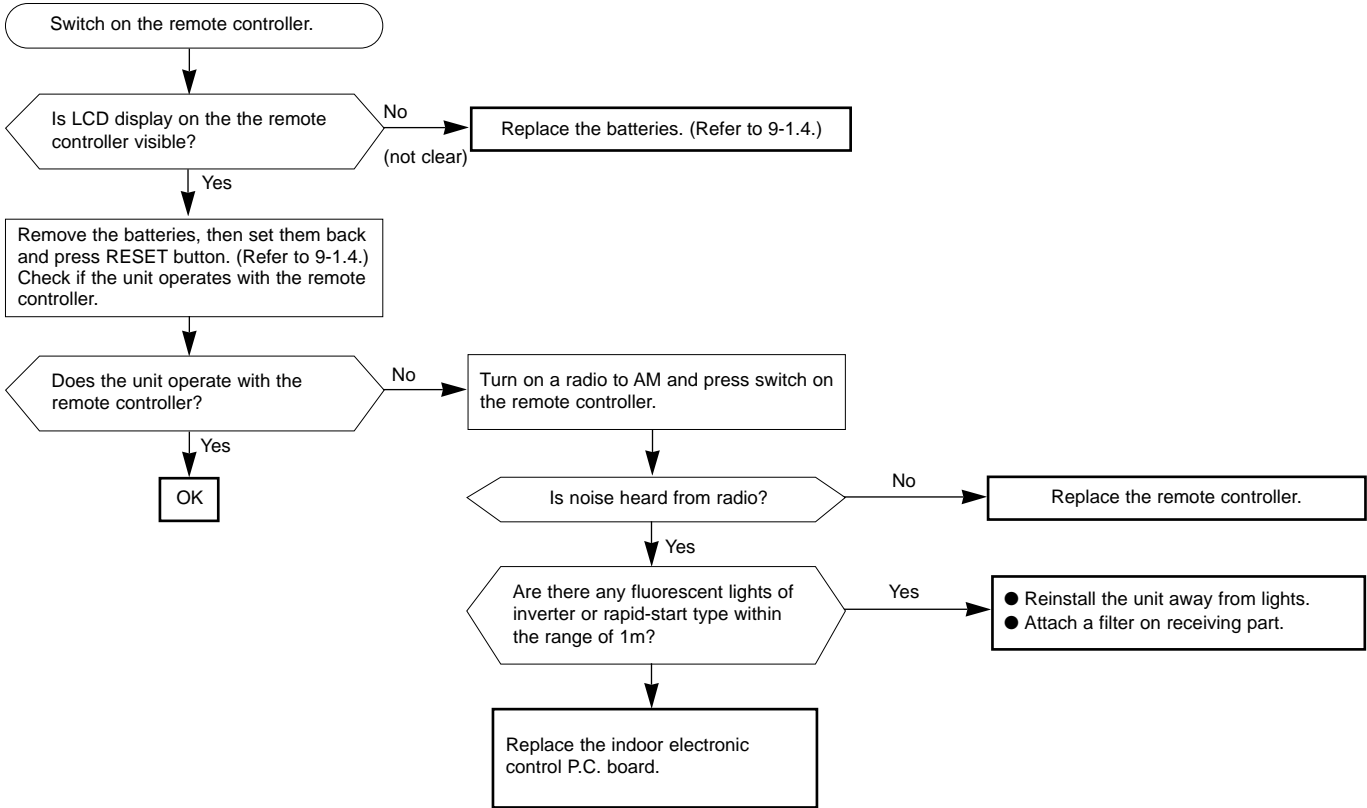

The unit does not operate with the remote controller.
 Also, POWER lamp does not light up by pressing EMERGENCY OPERATION switch.

© Check of indoor electronic control P.C. board and indoor fan motor

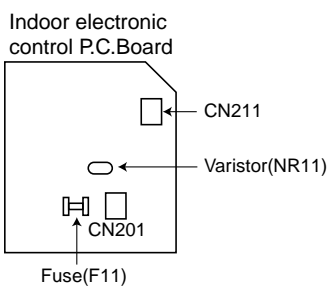
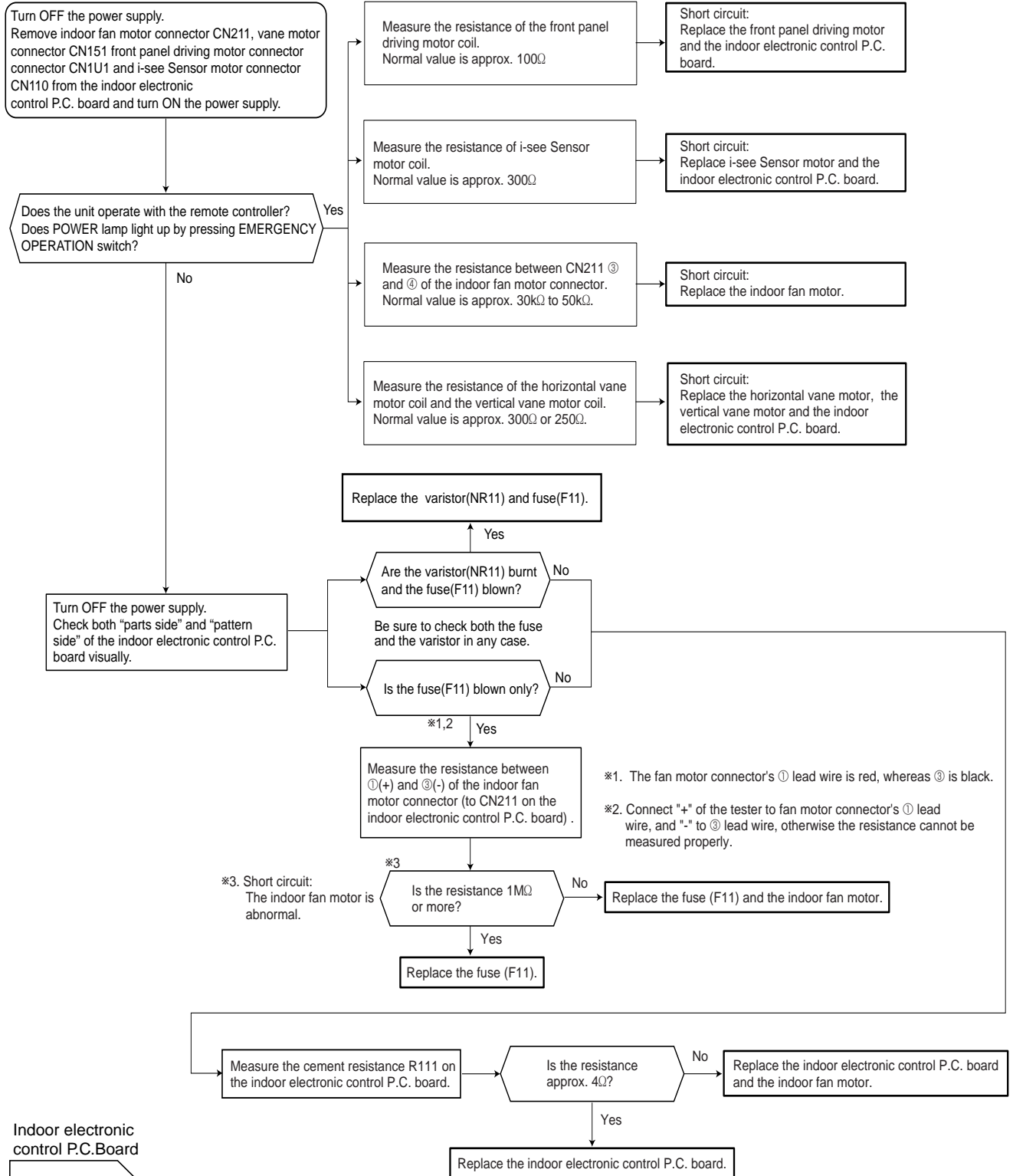

When POWER lamp flashes ON and OFF in every 0.5-second.
Outdoor unit does not operate.

D How to check mis-wiring and serial signal error

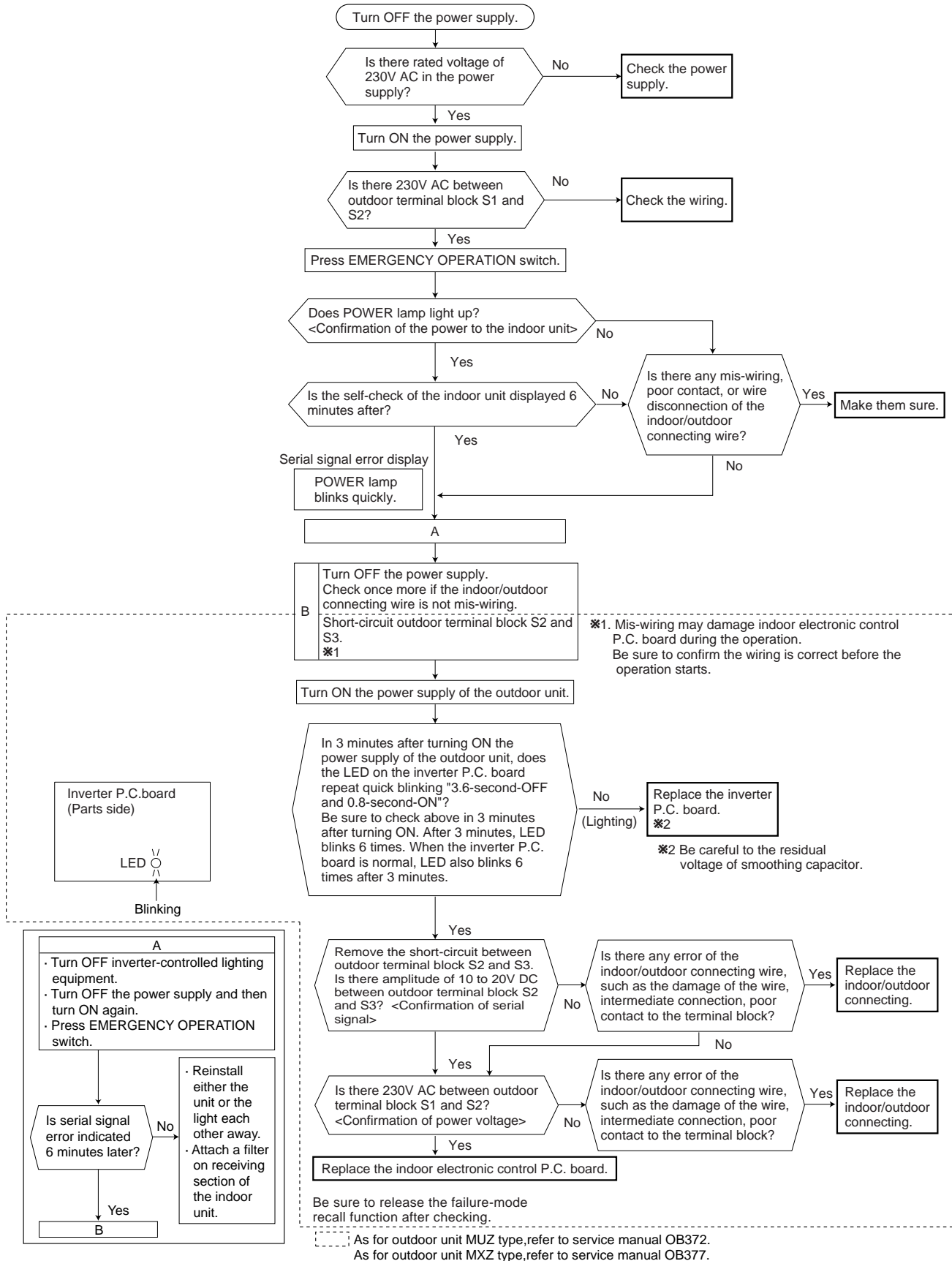

When All lamps flash ON and OFF every 0.5-second.
Indoor unit and outdoor unit do not operate.

Ⓔ Check of installation of the horizontal vane

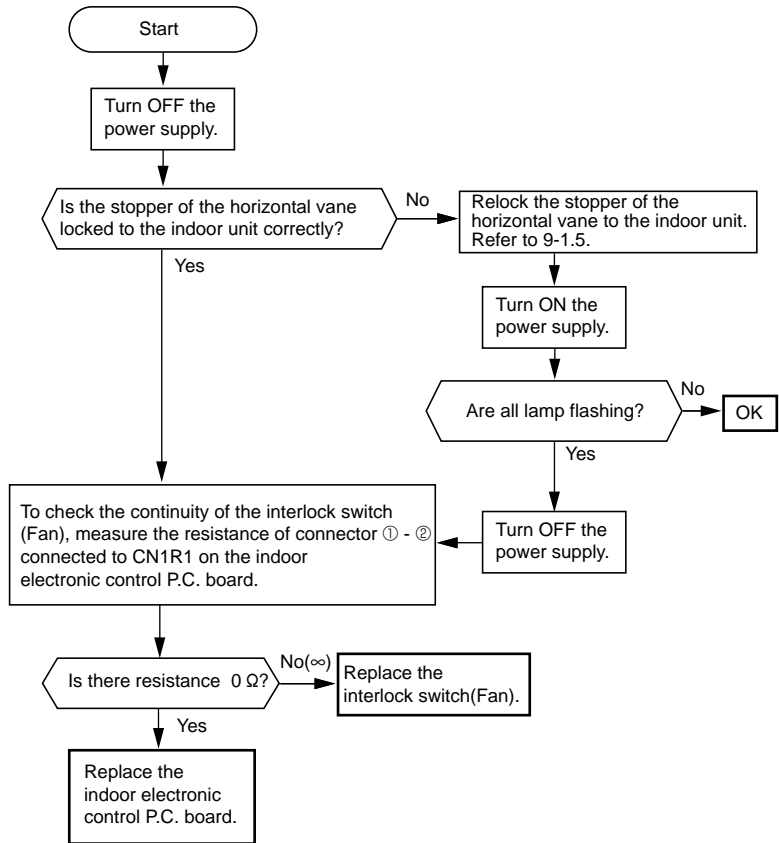

When PLASMA/WASH lamp flashes 2-time.

※The power failure mode for PLASMA DEODORIZING power is memorized when the failure mode is called.

F Check of PLASMA DEODORIZING power

After performing the check, make sure to release the failure mode recall function.

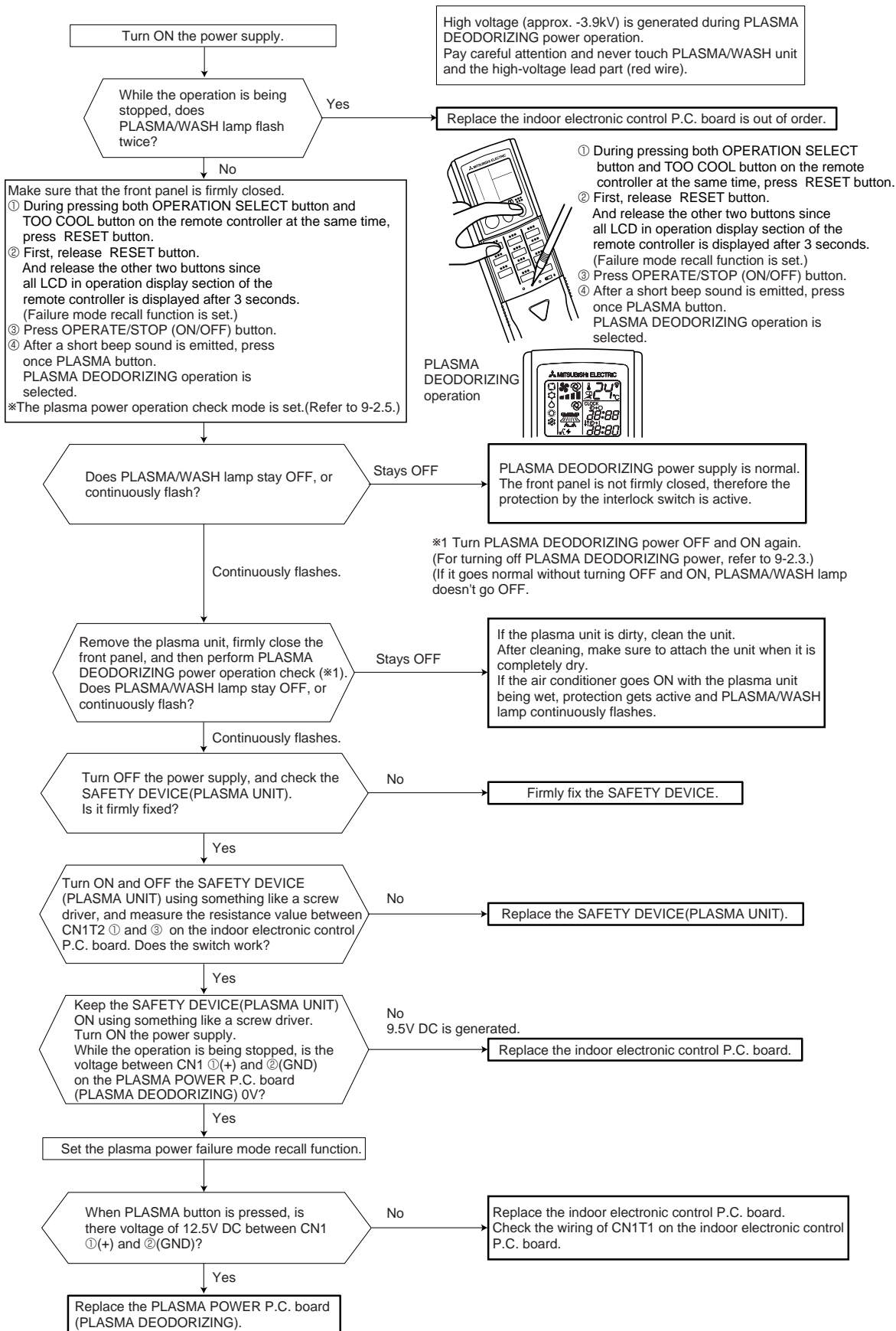

When PLASMA/WASH lamp flashes 2-time.

***The power failure mode for PLASMA AIR PURIFYING power is memorized when the failure mode is called.**

Ⓒ Check of PLASMA AIR PURIFYING power

After performing the check, make sure to release the failure mode recall function.

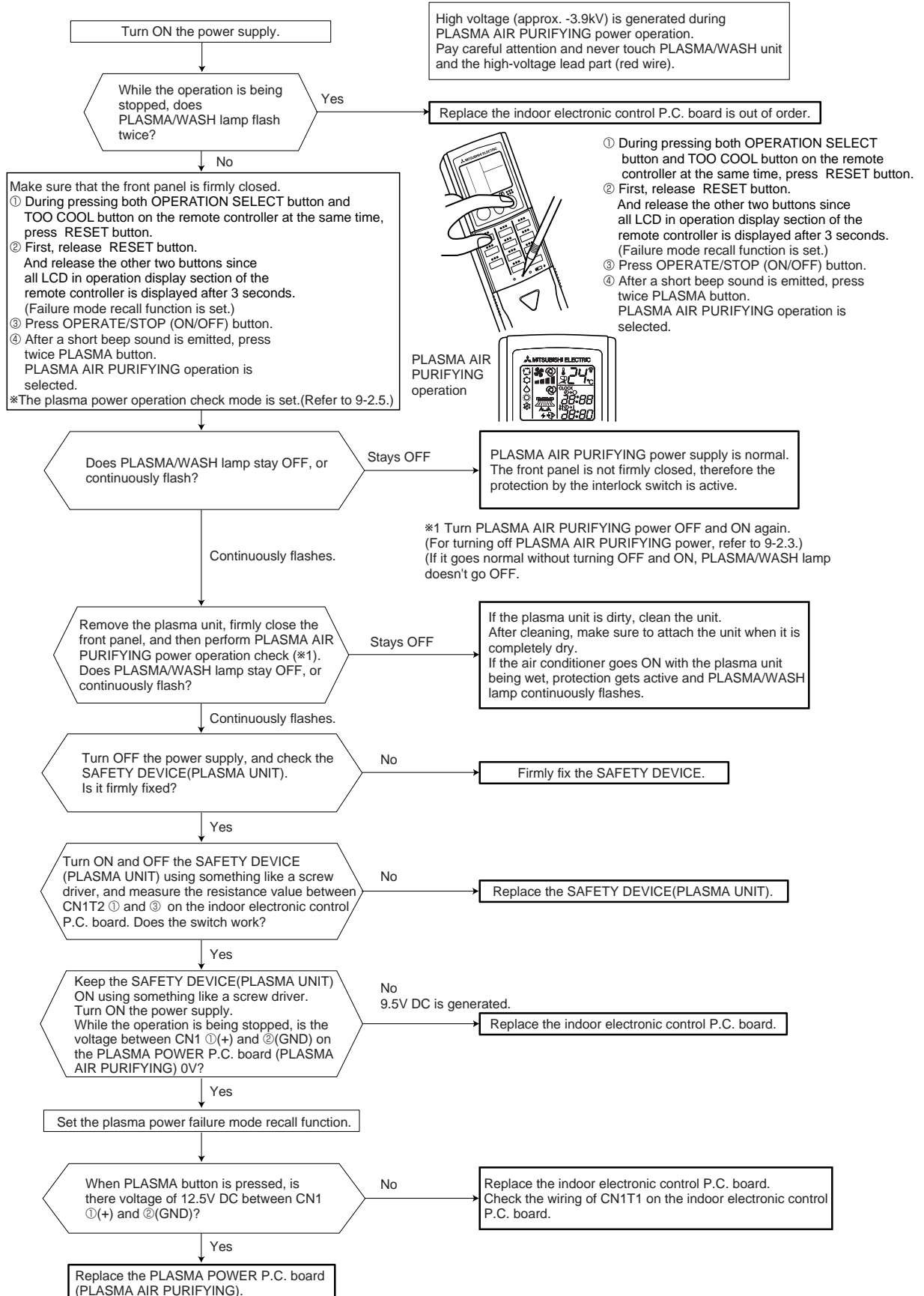

Indoor unit and outdoor unit do not operate.

H Check of auto front panel

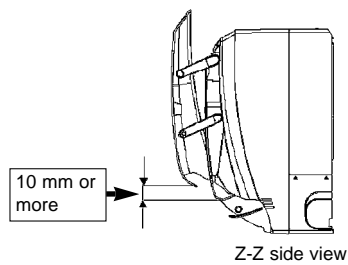
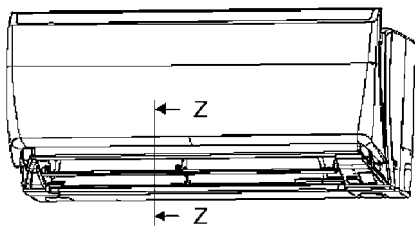
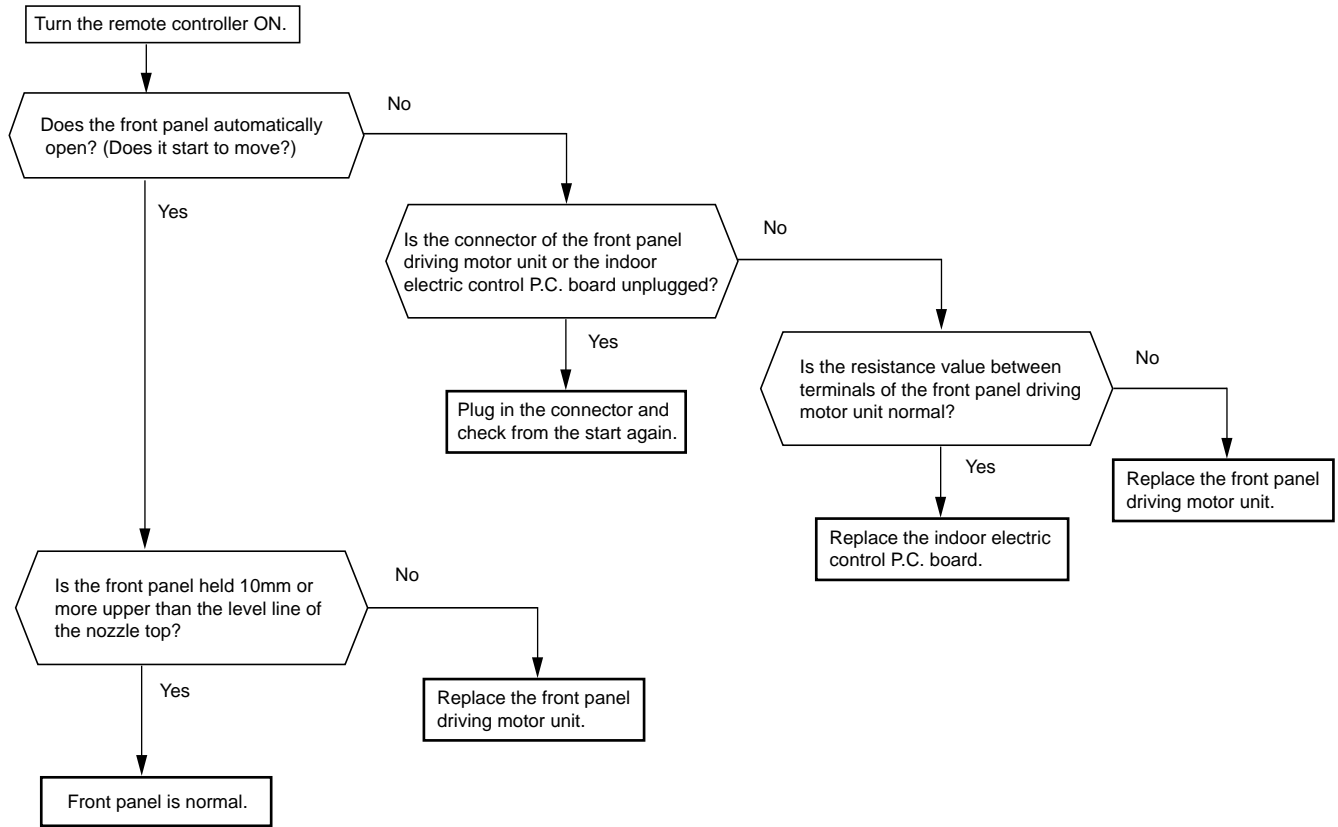

① Electromagnetic noise enters into TV sets or radios

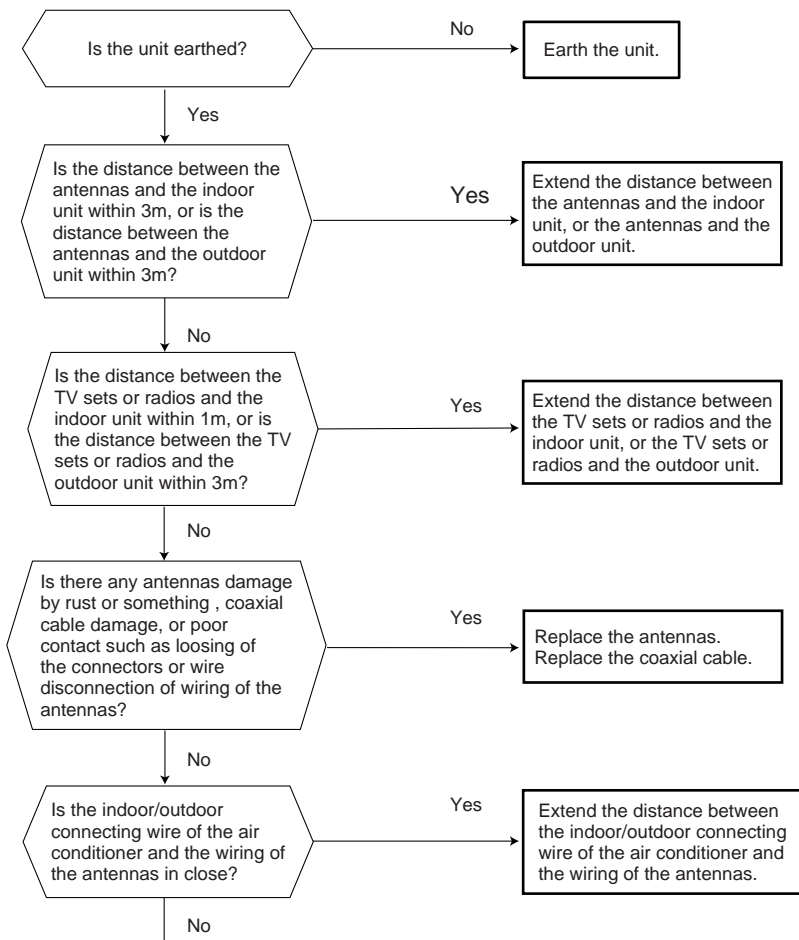

Even if all of the above conditions is fulfilled, the electromagnetic noise may enter, depending on the electric field strength or the installation condition (combination of specific conditions such as antennas or wiring).
 Check the followings before asking for service.

- 1.Devices affected by the electromagnetic noise
 TV sets, radios (FM/AM broadcast, shortwave)
- 2.Channel, frequency, broadcast station affected by the electromagnetic noise
- 3.Channel, frequency, broadcast station unaffected by the electromagnetic noise
- 4.Layout of ;
 indoor/outdoor unit of the air conditioner, indoor/outdoor wiring, grounding wire, antennas, wiring from antennas, receiver
- 5.Electric field intensity of the broadcast station affected by the electromagnetic noise
- 6.Presence or absence of amplifier such as booster
- 7.Operation condition of air conditioner when the electromagnetic noise enters in.
 - 1)Turn OFF the power supply once, and then turn ON the power supply. In this situation check for the electromagnetic noise.
 - 2)Within 3 minutes after turning ON the power supply, press OPERATE/STOP (ON/OFF) button on the remote controller for power-on, and check for the electromagnetic noise.
 - 3)After a short time (3 minutes later after turning ON), the outdoor unit starts running. During operation, check for the electromagnetic noise.
 - 4)Press OPERATE/STOP (ON/OFF) button on the remote controller for power off, when the outdoor unit stops but the indoor/outdoor communication still runs on. In this situation check for the electromagnetic noise.

After checking the above, consult the service representative.

9-7. Test point diagram and voltage

MSZ-FA25VA -[E1] MSZ-FA35VA -[E1]

Indoor electronic control P.C. board

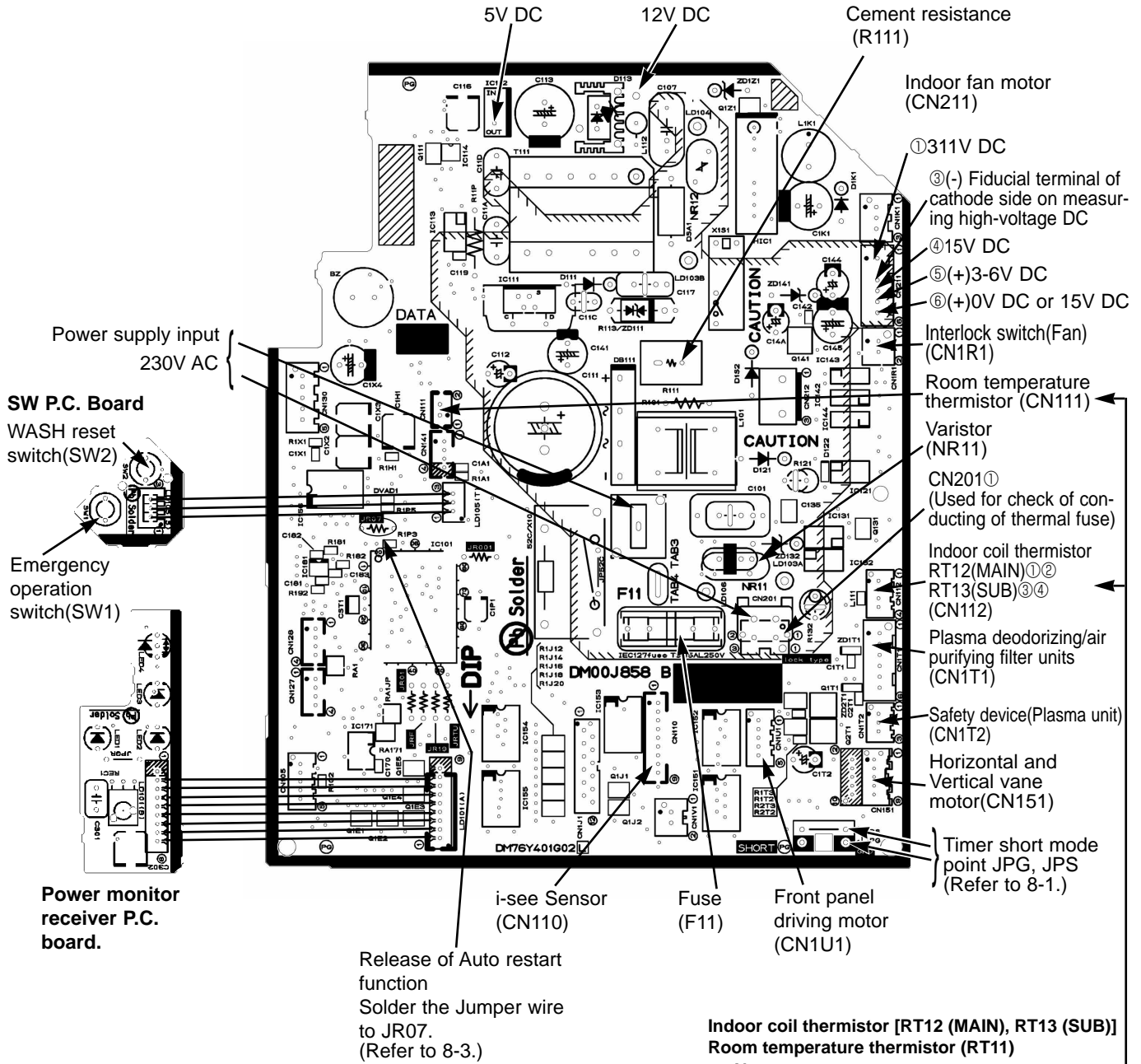

Plasma power P.C. board

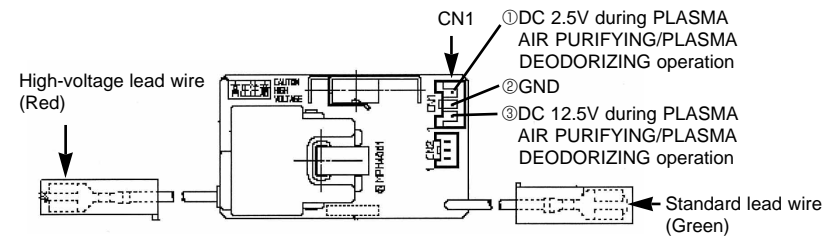

Indoor coil thermistor [RT12 (MAIN), RT13 (SUB)]
Room temperature thermistor (RT11)

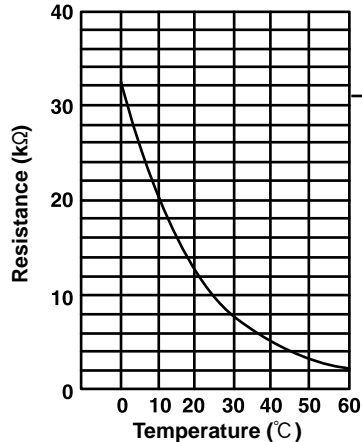

<"Terminal with locking mechanism" Detaching points>

The terminal which has the locking mechanism can be detached as shown below.
There are two types (Refer to (1) and (2)) of the terminal with locking mechanism.
The terminal without locking mechanism can be detached by pulling it out.
Check the shape of the terminal before detaching.

(1) Slide the sleeve and check if there is a locking lever or not.

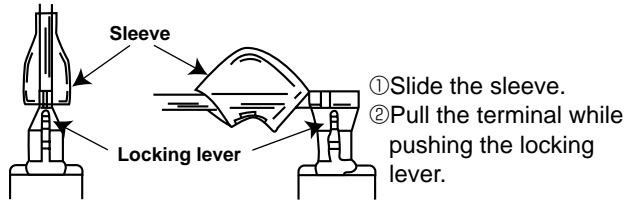

(2) The terminal with this connector has the locking mechanism.

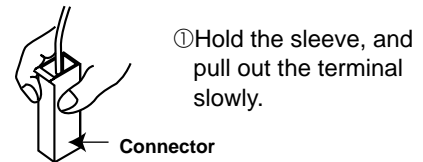

MSZ-FA25VA -[E1] MSZ-FA35VA -[E1]
INDOOR UNIT

OPERATING PROCEDURE**1. Removing the panel**

- (1) Press and unlock the knobs on both sides of the front panel and lift the front panel until it is level, and then pull the hinges forward to remove the front panel.
- (2) Remove the horizontal vane.
- (3) Remove the screw caps of the panel.
Remove the screws. (See Photo 1.)
- (4) Remove the screw of the front panel driving motor.
(See Photo 2.)
- (5) Hold the lower part of both ends on the panel and pull it slightly toward you, and then remove the panel by pushing it upward.

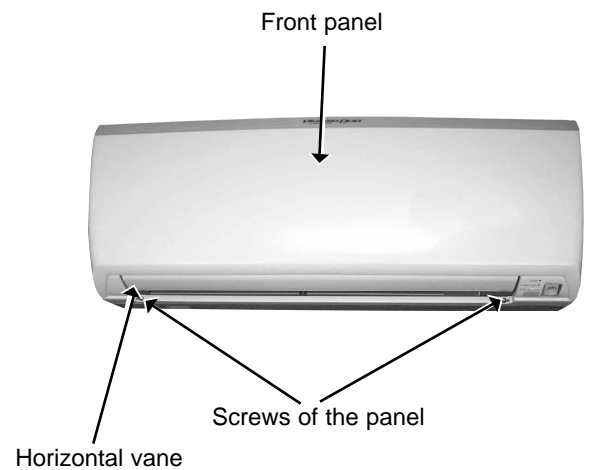
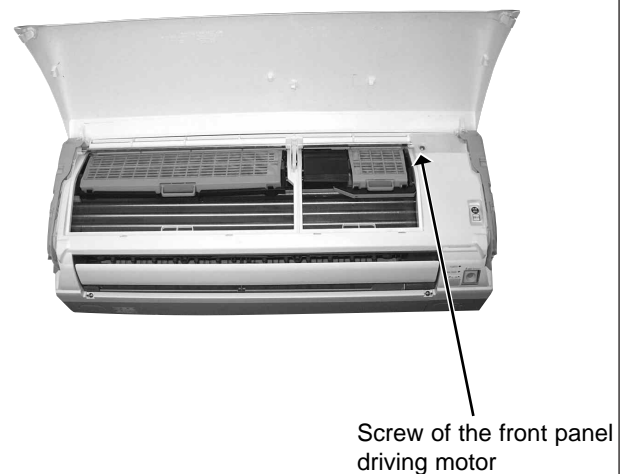
PHOTOS**Photo 1****Photo 2**

OPERATING PROCEDURE

2. Removing the electronic control P.C. board, the power monitor receiver P.C. board, i-see Sensor, SW P.C. board and the terminal block

- (1) Remove the horizontal vane, the panel (Refer to 1.) and the corner box.
- (2) Remove the screw of the V.A. clamp, and then the indoor/outdoor connecting wire.(See Photo 3.)
- (3) Remove the switch holder from the electrical cover. (See Photo 4.)
- (4) Remove the screw of the electrical cover, and then the electrical cover. (See Photo 4.)
- (5) Remove the ground wire connected to the indoor electronic control P.C. board from the electrical box. (See Photo 5.)
- (6) Unhook the power monitor receiver P.C. board holder from the catch. (See Photo 5.)
- (7) Open the rear cover of the power monitor receiver P.C. board holder and pull out the power monitor receiver P.C. board.
- (8) Remove the screws of the i-see Sensor cover and the i-see Sensor motor, and then the i-see Sensor motor.
- (9) Open the i-see Sensor holder and pull out the i-see Sensor.
- (10) Open the switch holder and pull out SW P.C. board.
- (11) Pull the electronic control P.C. board slightly toward you from the electrical box, and disconnect TAB3 and all the connectors on the electronic control P.C. board. (LD101 and LD105 are direct-mounted to the electronic control P.C. board.)
- (12) Pull out the electronic control P.C. board from the electrical box.
- (13) Remove the ground wire connected to the heat exchanger from the electrical box. (See Photo 5.)
- (14) Unhook the catches of the electrical box, and pull out the electrical box.
- (15) Remove the screws of the terminal block cover, and then the terminal block cover and the terminal block holder. (See Photo 3.)
- (16) Remove the terminal block by sliding it.

3. Removing the electrical box

- (1) Remove the horizontal vane, the panel (Refer to 1.) and the corner box.
- (2) Remove the screw of the V.A. clamp, and then the indoor/outdoor connecting wire.(See Photo 3.)
- (3) Remove the switch holder and the electrical cover. (See Photo 4.)
- (4) Remove the ground wire connected to the heat exchanger from the electrical box.(See Photo 5.)
- (5) Disconnect the following connectors on the electronic control P.C. board; the fan motor connector <CN211>, the indoor coil thermistor connector <CN112>, the vane motor connector <CN151>, the connector of the interlock switch (Fan) of the horizontal vane <CN1R1>, the connector of the safety device (plasma unit) <CN1T2>, the connector of the plasma power P.C. board <CN1T1>, the connector of the front panel driving motor <CN1U1>.
- (6) Unhook the catches of the electrical box, and pull out the electrical box. (See Photo3.)

PHOTOS

Photo 3

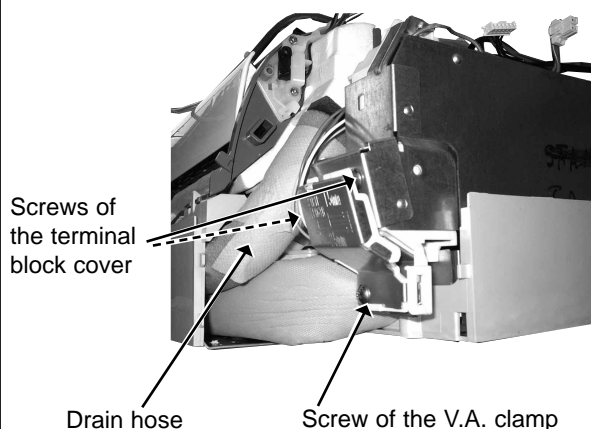

Photo 4

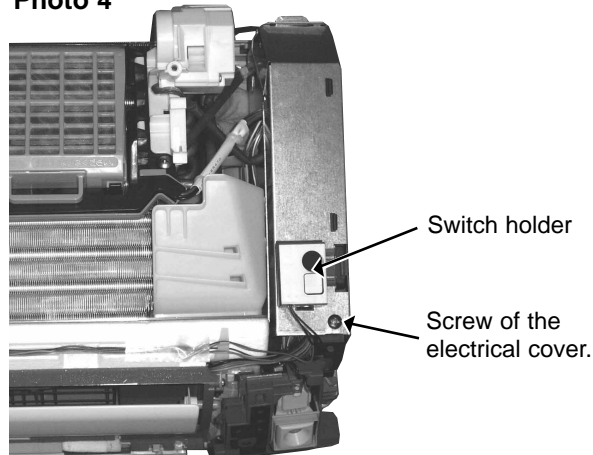
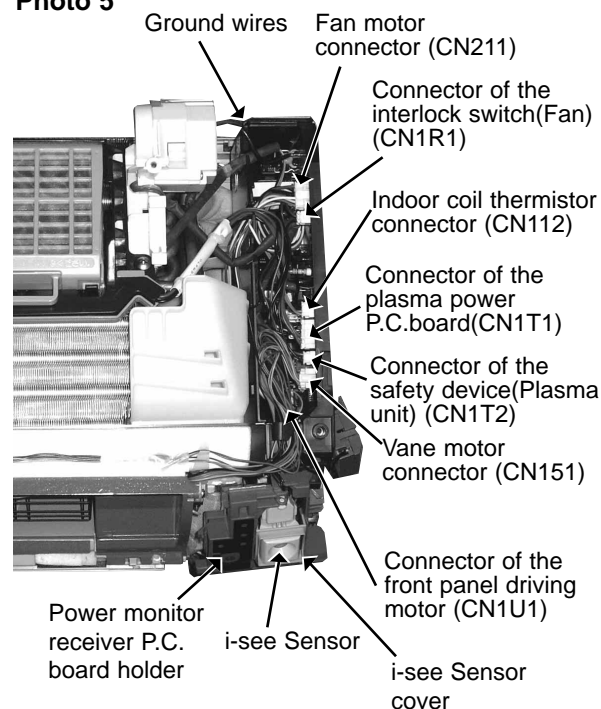

Photo 5



OPERATING PROCEDURE

4. Removing the horizontal vane motor unit

- (1) Remove the horizontal vane and the panel. (Refer to 1.)
- (2) Remove the screws of the horizontal vane motor unit, and pull out the horizontal vane motor unit. (See Photo 6.)
- (3) Disconnect the connector from the horizontal vane motor unit.

Photo 6

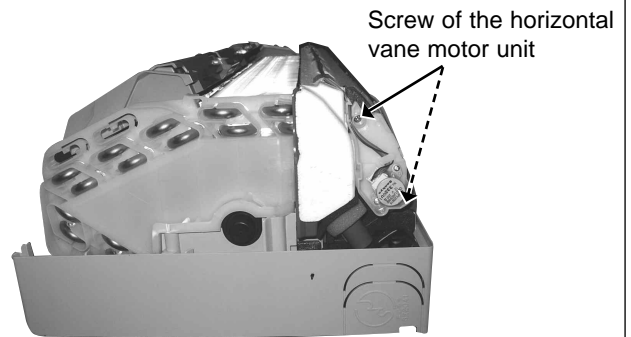

5. Removing the vertical vane motor unit

- (1) Remove the horizontal vane, the panel (Refer to 1.) and the corner box.
- (2) Pull out the drain hose from the nozzle assembly, and remove the nozzle assembly. (See Photo 5.)
- (3) Remove the crank of the vertical vane motor unit from the arm of the vertical vane. (See Photo 7.)
- (4) Remove the screws of the vertical vane motor unit, and pull the vertical vane motor unit. (See Photo 7.)

Photo 7

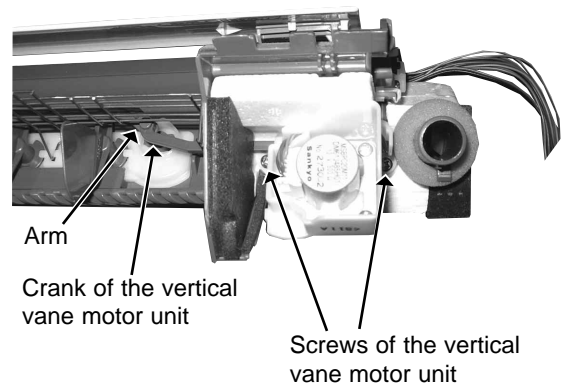

6. Removing the indoor fan motor and the line flow fan

- (1) Remove the horizontal vane, the panel (Refer to 1.) and the corner box.
- (2) Remove the switch holder and the electrical box. (Refer to 3.)
- (3) Pull out the drain hose from the nozzle assembly, and remove the nozzle assembly.
- (4) Remove the screws fixing the motor bed. (See Photo 8.)
- (5) Loosen the screw fixing the line flow fan. (See Photo 9.)
- (6) Remove the motor bed together with fan motor and motor band.
- (7) Release the hooks of the motor band, and remove the motor band then pull out the indoor fan motor.
- (8) Remove the screws fixing the left side of the heat exchanger. (See Photo 10.)
- (9) Lift the heat exchanger, and pull out the line flow fan to the lower-left.

Photo 8

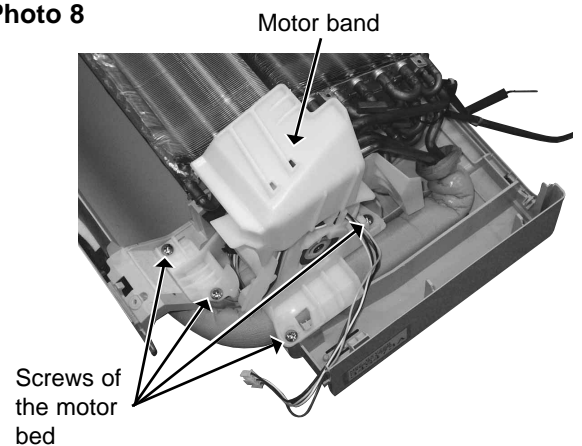

Photo 9

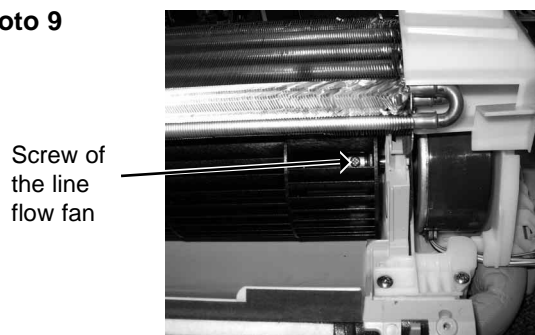
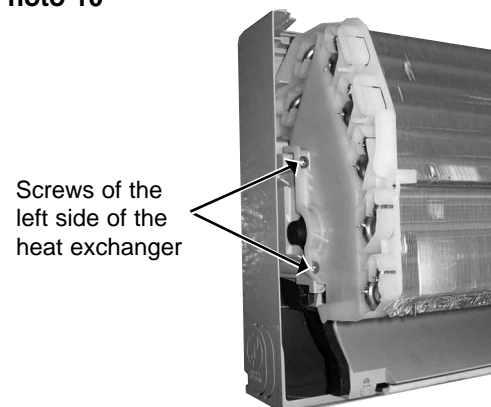

Photo 10



OPERATING PROCEDURE

7. Removing the plasma power P.C. board

- (1) Remove the horizontal vane, the panel (Refer to 1.) and the corner box.
- (2) Remove the switch holder and the electrical cover. (Refer to 3.)
- (3) Disconnect the connector of the front panel driving motor <CN1U1> from the electronic control P.C. board.
- (4) Remove the front panel driving motor.
- (5) Remove the screw of the plasma element holder, and remove the plasma element holder from the heat exchanger. (See Photo 11.)
- (6) Unhook all the catches of plasma unit cover and remove the plasma unit cover. (See Photo 12.)
- (7) Remove the terminals with locking mechanism connected to the plasma power P.C. board and the safety device (Plasma unit). (See Photo 13.)
- (8) Remove the plasma electrical box from the plasma element holder.
- (9) Remove the screw fixing the plasma electrical box, and open the plasma electrical box then pull out the plasma power P.C. board from the plasma electrical box. (See Photo 13.)

PHOTOS

Photo 11

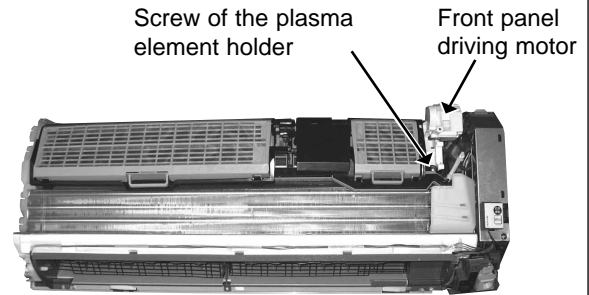

Photo 12

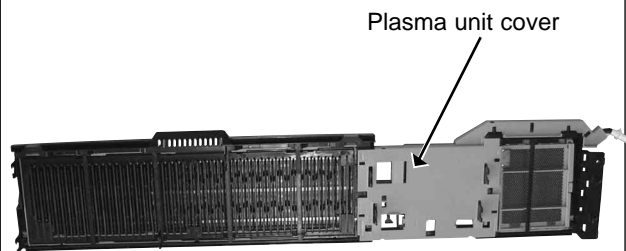
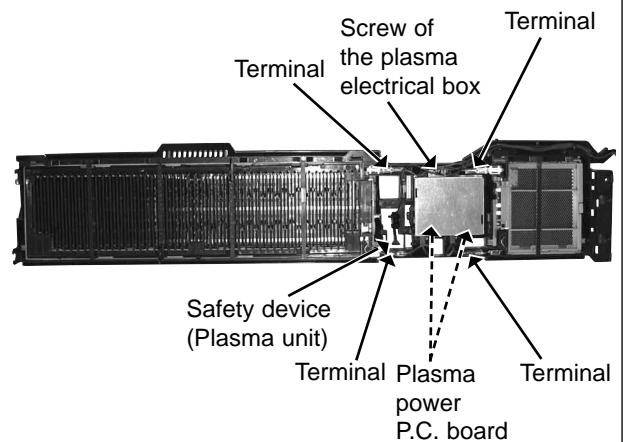

Photo 13



11

PARTS LIST

MSZ-FA25VA -E1 (WH)

MSZ-FA35VA -E1 (WH)

11-1. INDOOR UNIT STRUCTURAL PARTS

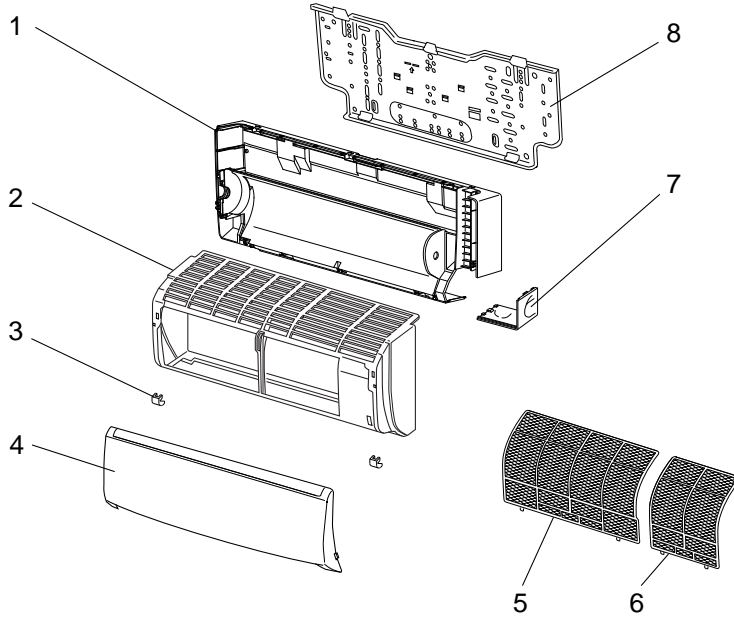

11-2. ACCESSORY AND REMOTE CONTROLLER

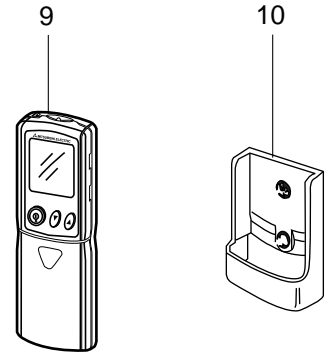

11-1. INDOOR UNIT STRUCTURAL PARTS

No.	Part No.	Part name	Symbol in Wiring Diagram	Q'ty/unit		Remarks
				MSZ-FA25VA -E1 (WH)	MSZ-FA35VA -E1 (WH)	
1	E02 897 234	BOX		1	1	
2	E02 913 000	PANEL ASSEMBLY (WH)		1	1	Including No.3,4
3	E02 913 067	SCREW CAP		2	2	2PCS/SET
4	E02 913 010	FRONT PANEL (WH)		1	1	
5	E02 914 100	AIR FILTER (LEFT)		1	1	
6	E02 913 100	AIR FILTER (RIGHT)		1	1	
7	E02 913 975	CORNER BOX (RIGHT)		1	1	
8	E02 913 970	INSTALLATION PLATE		1	1	

11-2. ACCESSORY AND REMOTE CONTROLLER

9	E02 913 426	REMOTE CONTROLLER		1	1	KM05A
10	E02 527 083	REMOTE CONTROLLER HOLDER		1	1	

MSZ-FA25VA -E1 (WH)
MSZ-FA35VA -E1 (WH)

11-3. INDOOR UNIT ELECTRICAL PARTS AND FUNCTIONAL PARTS

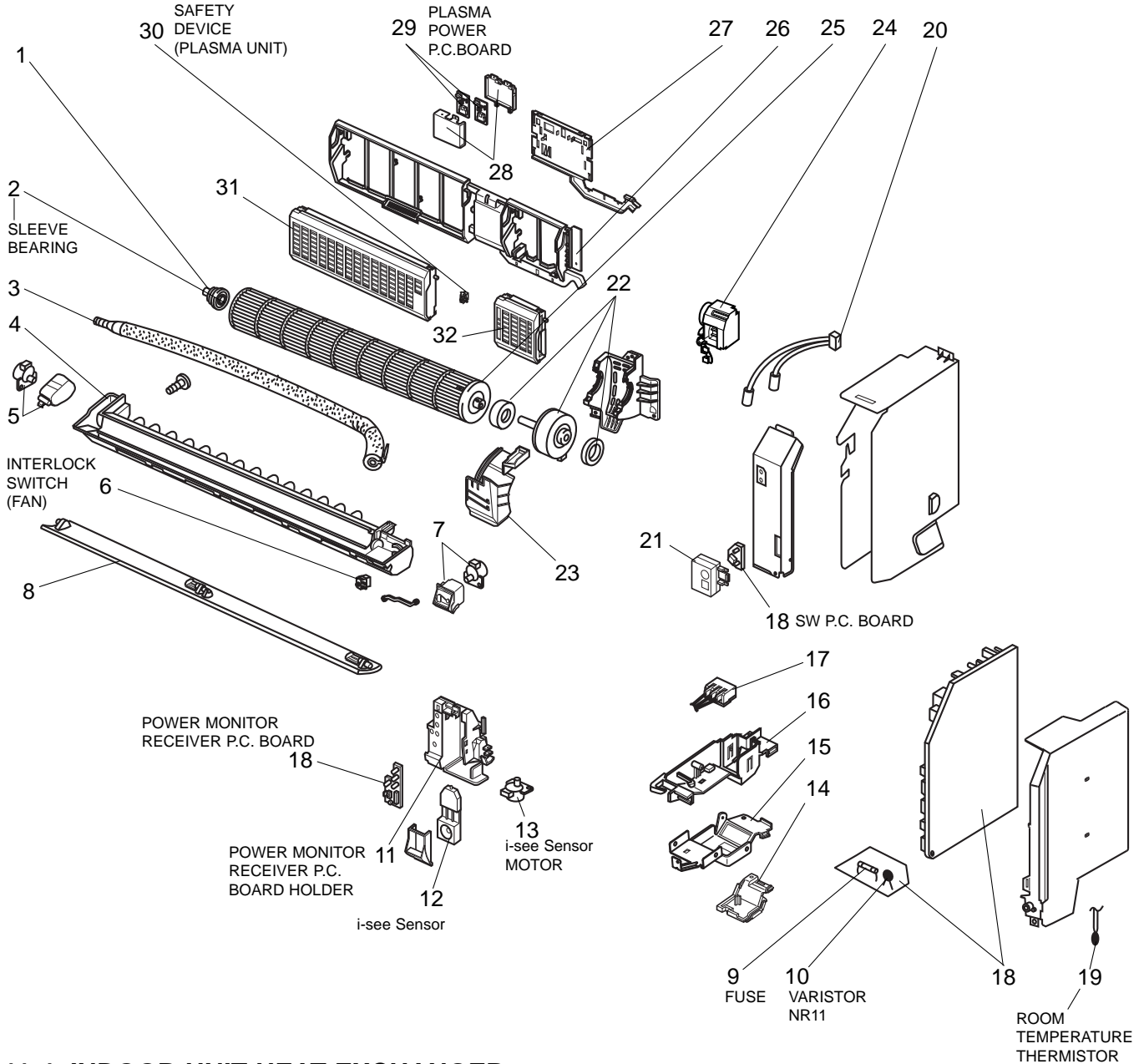

11-4. INDOOR UNIT HEAT EXCHANGER

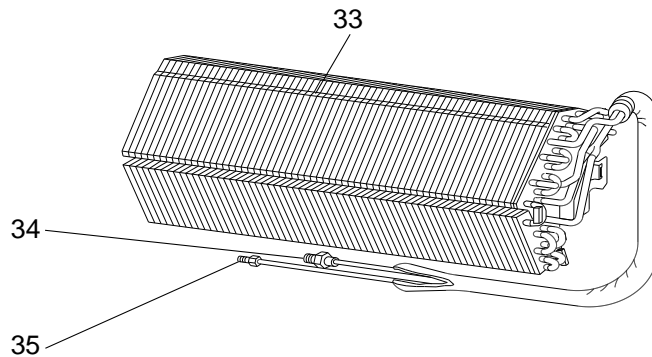

11-3. INDOOR UNIT ELECTRICAL PARTS AND FUNCTIONAL PARTS

No.	Part No.	Part name	Symbol in Wiring Diagram	Q'ty/unit		Remarks
				MSZ-FA25VA- ^{E1} (WH)	MSZ-FA35VA- ^{E1} (WH)	
1	E02 751 509	BEARING MOUNT		1	1	
2	E02 001 504	SLEEVE BEARING		1	1	
3	E02 897 702	DRAIN HOSE		1	1	
4	E02 913 235	NOZZLE ASSEMBLY		1	1	
5	E02 897 303	VANE MOTOR UNIT (HORIZONTAL)	MV1	1	1	UP & DOWN
6	E02 897 316	INTERLOCK SWITCH(FAN)		1	1	
7	E02 913 303	VANE MOTOR UNIT (VERTICAL)	MV2	1	1	RIGHT & LEFT
8	E02 913 040	HORIZONTAL VANE		1	1	
9	E02 127 382	FUSE	F11	1	1	3.15A
10	E02 661 385	VARISTOR	NR11	1	1	
11	E02 913 095	POWER MONITOR RECEIVER P.C. BOARD HOLDER		1	1	
12	E02 913 391	i-see Sensor	RR	1	1	
13	E02 914 303	i-see Sensor MOTOR	MT	1	1	
14	E02 897 784	VA CLAMP		1	1	
15	E02 897 780	TERMINAL BLOCK COVER		1	1	
16	E02 897 779	TERMINAL BLOCK HOLDER		1	1	
17	E02 913 375	TERMINAL BLOCK	TB	1	1	
18	E02 913 452	ELECTRONIC CONTROL P.C. BOARD *1		1		AUTO RESTART
	E02 914 452	ELECTRONIC CONTROL P.C. BOARD *1			1	AUTO RESTART
19	E02 897 308	ROOM TEMPERATURE THERMISTOR	RT11	1	1	
20	E02 913 307	INDOOR COIL THERMISTOR	RT12, RT13	1		
	E02 914 307	INDOOR COIL THERMISTOR	RT12, RT13		1	
21	E02 913 782	SWITCH HOLDER		1	1	
22	E02 897 300	INDOOR FAN MOTOR *2	MF	1	1	RC0J40-□□
23	E02 897 333	MOTOR BAND		1	1	
24	E02 898 303	FRONT PANEL DRIVING MOTOR	MP	1	1	
25	E02 897 302	LINE FLOW FAN		1	1	
26	E02 913 775	PLASMA ELEMENT HOLDER		1	1	
27	E02 913 776	PLASMA UNIT COVER		1	1	
28	E02 913 777	PLASMA ELECTRICAL BOX		1	1	
29	E02 897 440	PLASMA POWER P.C. BOARD		2	2	
30	E02 898 316	SAFETY DEVICE (PLASMA UNIT)		1	1	
31	E02 913 774	PLASMA AIR PURIFYING FILTER UNIT	PLASMA_A	1	1	
32	E02 914 774	PLASMA DEODORIZING FILTER UNIT	PLASMA_D	1	1	

*1 Including SW P.C. BOARD and POWER MONITOR RECEIVER P.C. BOARD

*2 Including FAN MOTOR RUBBER MOUNT (2 PCS/SET)

11-4. INDOOR UNIT HEAT EXCHANGER

33	E02 913 620	INDOOR HEAT EXCHANGER		1		
	E02 914 620	INDOOR HEAT EXCHANGER			1	
34	E02 815 666	UNION (GAS)		1	1	φ9.52
35	E02 151 667	UNION (LIQUID)		1	1	φ6.35

DEODORIZING CERAMIC FILTER

Replacement of the deodorizing ceramic filter(about once every 6 years)

Deodorizing ceramic filter is installed inside PLASMA DEODORIZING filter unit. The filter is fragile. Handle it with care.

NOTE: PLASMA DEODORIZING filter unit may not operate properly if the deodorizing ceramic filter is not installed.

Be sure to install the deodorizing ceramic filter.

(1) Release the two knobs to open the filter unit.

(2) Pull the side knobs to outward and then forward to remove, as illustrated below.

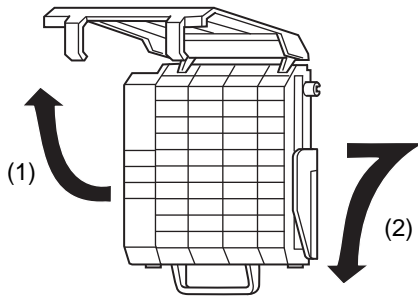

(3) Pull out the deodorizing ceramic filter from the side of the filter unit.

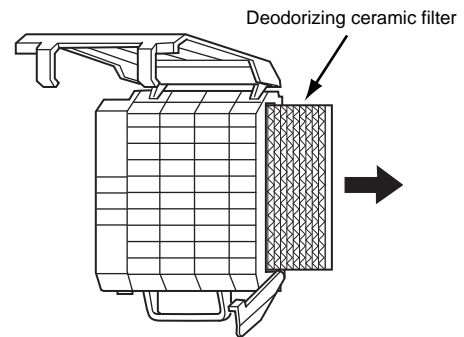

(4) Install the deodorizing ceramic filter by following the removal procedure in reverse.

Model	Part No.
MSZ-FA25VA -E1	MAC-305FT-E
MSZ-FA35VA -E1	



© Copyright 2005 MITSUBISHI ELECTRIC ENGINEERING CO.,LTD
Distributed in Jan. 2005. No. OB371 6
Made in Japan

New publication, effective Jan. 2005
Specifications subject to change without notice.